

Luminum®

VALAISINKUVUT



PALLOKUVUT

Pallokuvut ovat erinomainen ulkovalaisimien vaihtoehto. Kauttamme voitte tilata pallokupuja lähes kaikkiin valaisintyyppiin. Pallokupujen valmistusmateriaaleja ovat polykarbonaatti- tai akryylimuovi. Nämä muovit ovat erittäin kestäviä ja pitkäikäisiä.



Vakiomalliemme pallokuvun halkaisijat: 160 mm, 190 mm, 200 mm, 250 mm, 300 mm, 400 mm 500 mm ja 600 mm. Ø 250 mm pallo soveltuu käytettäväksi seinäkiinnikkeen kanssa seinäpinnoissa, kun taas Ø 300 mm ja Ø 400 mm kupujen käyttökohteet ovat usein pylväsalaisimissa.

Ø mm	KOODI	VÄRI	Kierre/kanta/aukko mm	KIINNITYKSEN MITAT			SOPII TUOTTEISIIN	SÄHKÖ-NUMERO	
Ø 160/190/200				A	B	C			
160	AT2400	opaali	kierre	85	85	75	70		42 390 22
190	AT2450	opaali	kierre	100	100	90	84		42 390 21
190	AT2451	opaali	bajonetti/rk	100	100	92	82		42 390 23
200	AT200100OP	opaali	aukko	100	100			Orno 971-529	
200	AT2420	opaali	kierre	85	85	75	70		
200	AT20085OPK-K	opaali	kierre	85	85	75	70	Ketonen	
Ø 250	KOODI	VÄRI	Kierre/kanta/aukko mm	A	B	C	SOPII TUOTTEISIIN		
250	AT25085OPK	opaali	kierre	85	85	75	70		45 147 21
250	AT25085KK	kirkas	kierre	85	85	75	70		45 147 22
250	AT25085OPK-K	opaali	kierre	85				Ketonen	
250	AT250100OP	opaali	aukko	100	100				45 147 16
250	AT250100K	kirkas	aukko	100	100				45 147 17
250	AT250100KB	kirkas	bajonetti/rk	100	100	92	85		45 147 18
250	AT250100OPB	opaali	bajonetti/rk	100	100	92	85		
250	AT250100OPK	opaali	kierre	100	100	92	85		45 147 23
250	AT250100KK	kirkas	kierre	100	100	92	85		45 147 24
250	AT250120KB	kirkas	bajonetti	120	120	100	90	Orno Bolero	45 147 07
250	AT250120OPB	opaali	bajonetti	120	120	100	90	Orno Bolero I-valo 4008-250	45 147 06
250	AT250125OP	opaali	aukko	125					
250	AT250125K	kirkas	aukko	125	125				
250	AT250125OPK	opaali	kierre	125	125	115	110		45 147 19
250	AT250125KK	kirkas	kierre	125	125	115	110		45 147 20

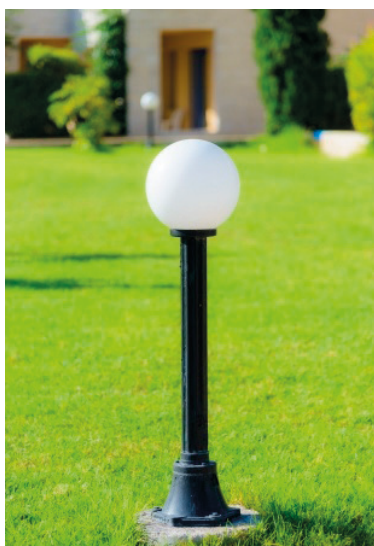

PALLOKUVUT

Ø 300	KOODI	VÄRI	Kierre/kanta/aukko	mm	A	B	C	SOPII TUOTTEISIIN	
300	AT300100KB	kirkas	bajonetti/rk	100	100	92	85		
300	AT300100PB	opaali	bajonetti /rk	100	100	92	85		
300	AT300100PK	opaali	kierre	100	100	92	85		
300	AT300100KK	kirkas	kierre	100	100	92	85		
300	AT300105K	kirkas	aukko	105	105				
300	AT300105OP	opaali	aukko	105	105				
300	AT300120OP	opaali	aukko	120	120				
300	AT300120K	kirkas	aukko	120	120				
300	AT300120KB	kirkas	aukko	120	120				
300	AT300120PB	opaali	aukko	120	120				
300	AT300125OPK	opaali	kierre	125	125	115	110		45 147 27
300	AT300125KK	kirkas	kierre	125	125	115	110		45 147 28
300	AT300140KB	kirkas	bajonetti	140	140	120	110	Orno Bolero	45 147 09
300	AT300140OP	opaali	aukko	140	140				
300	AT300140OPB	opaali	bajonetti	140	140	120	110	Orno Bolero	45 147 08
300	AT300150OP	opaali	aukko	150	150				45 147 29
300	AT300150K	kirkas	aukko	150	150				
300	AT300160PB	opaali	bajonetti	160	165	100	150	Alppilux AT4302	45 147 30
300	AT300160SB	savu	bajonetti	160	165	100	150	Alppilux AT4302	45 147 31
300	AT300160KB	kirkas	bajonetti	160	165	100	150	Alppilux AT4302	45 147 32
300	AT300150LOP	opaali	aukko kolme lovea	150	150			AT3160/3140/3300	45 147 41
Ø 400	KOODI	VÄRI	Kierre/kanta/aukko	mm	A	B	C	SOPII TUOTTEISIIN	
400	AT400150K	kirkas	aukko	150	150			Orno 140-049K	45 147 10
400	AT400150OP	opaali	aukko	150	150			Orno 140-049OP	45 035 64
400	AT400150KB	kirkas	bajonetti	150	150	140	130		
400	AT400150PB	opaali	bajonetti	150	150	140	130		
400	AT400180KB	kirkas	bajonetti	180	180	160	150	Orno Bolero K	45 147 11
400	AT400180PB	opaali	bajonetti	180	180	160	150	Orno Bolero OP	45 147 12
400	AT400195K	kirkas	aukko	195	195			Globus Idman	45 147 13
400	AT400195OP	opaali	aukko	195	195			Globus Idman	45 147 14
400	AT400200SB	savu	bajonetti	200	205	200	193	Alplux AT4400	
400	AT400200KB	kirkas	bajonetti	200	205	200	193	Alppilux AT4400	45 147 37
400	AT400200PB	opaali	bajonetti	200	205	200	193	Alppilux AT4400	45 147 36
400	AT400200OP	opaali	aukko	200					
400	AT400200K	kirkas	aukko	200					
Ø 500	KOODI	VÄRI	Kierre/kanta/aukko	mm	A	B	C	SOPII TUOTTEISIIN	
500	AT500218OPB	opaali	bajonetti	500	500	218	188		
500	AT500218KB	kirkas	bajonetti	500	500	218	188		
Ø 600	KOODI	VÄRI	Kierre/kanta/aukko	mm	A	B	C	SOPII TUOTTEISIIN	
600	AT600272OPB	opaali	bajonetti	600	600	272	242		
600	AT600272KB	kirkas	bajonetti	600	600	272	242		



PALLOKUVUT

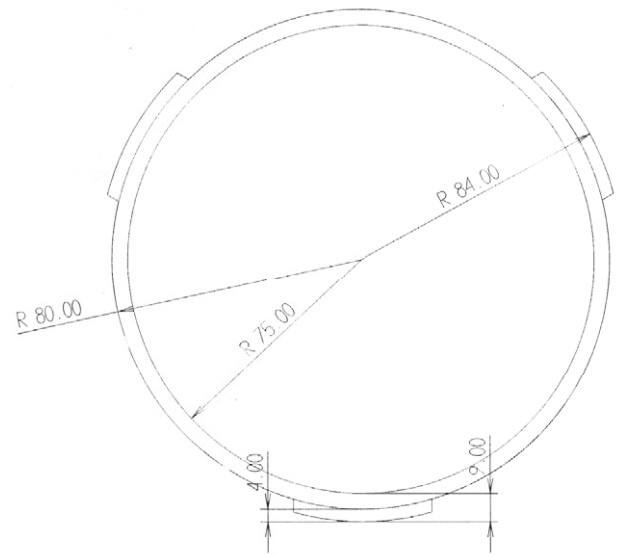
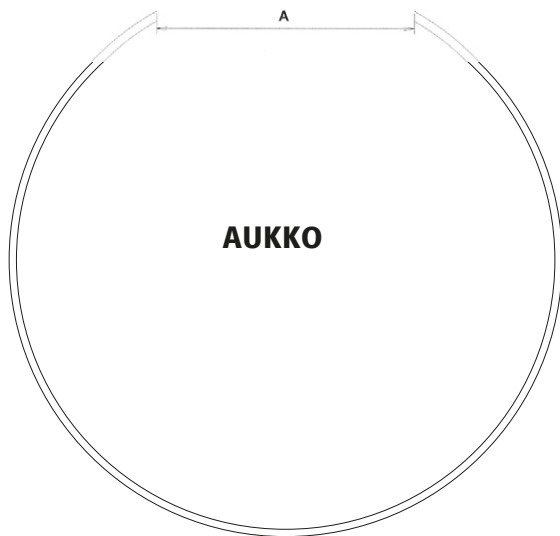
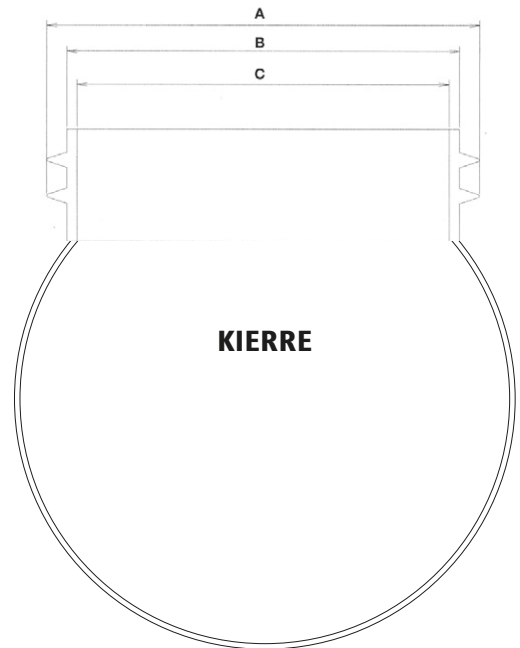

AT300160

VALAISINKANNAT JA SEINÄVARRET PALLOKUVUILLE

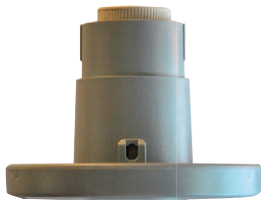

LUKA0251/PCH

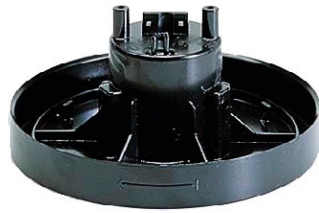

LUKA0500/PCM

Pallokuvuille on saatavissa nyt myös kannat pylväs- ja seinävalaisimiin. Valaisimien kannat soveltuvat Ø 250 mm ja Ø 300 mm pallokuvuille.

Väreinä moderni harmaa, RAL 7040 ja perinteinen musta, RAL 9005. Materiaali polykarbonaatti.

Toimitamme tilauksesta myös Ø 400 mm pallokupujen kannat.

KOODI	TUOTE	VÄRI	TEHO	PYLVÄÄN Ø mm	SOPII PALLOKUPIIHIN
LUKA0251/PCH	Kanta 200/250 mm pallokuvulle	harmaa	E27 max 60W	Ø 42–60	AT250120OPB
LUKA0251/PCM	Kanta 200/250 mm pallokuvulle	musta	E27 max 60W	Ø 42–60	AT250120OPB
LUKA0301/PCH	Kanta 300 mm pallokuvulle	harmaa	E27 max 60W	Ø 42–60	AT300140OPL, AT300140OPL, AT300140KB
LUKA0301/PCM	Kanta 300 mm pallokuvulle	musta	E27 max 60W	Ø 42–60	AT300140OPL, AT300140OPL, AT300140KB
LUKA0401/PCM	Kanta 400 mm pallokuvulle	musta	E27 max 60W	Ø 60	AT400180KB, AT400180OPB
LUKA0500/PCM	Kanta 500 mm pallokuvulle	musta	E27 max 60W	Ø 60	
LUKA0600/PCM	Kanta 600 mm pallokuvulle	musta	E27 max 60W	Ø 60	

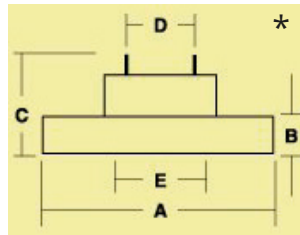
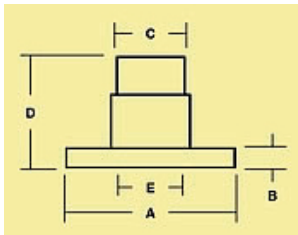

KOODI	A mm	B mm	C mm	D mm	E Ø mm
LUKA0201	106	19	52	80	42
LUKA0251	126	20	59	93	42 – 60
LUKA0301	146	20	59	100	42 – 60
LUKA0401	186	20	59	100	60
*LUKA0500	227	26	122	53	60
*LUKA0600	282	29	174	53	60

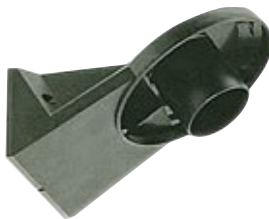

LUSK250/PCM

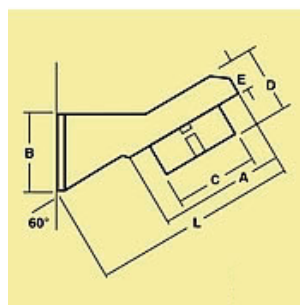

KOODI	A mm	B mm	C mm	D mm	E mm	L mm
LUSK250/PCM	123	64	61	59	27	180
LUSK300/PCM	150	78	61	59	27	218

KOODI	TUOTE	VÄRI	TEHO	SOPII PALLOKUPIIHIN
LUSK250/PCM	Seinävarsi 250 mm pallokuvulle	musta	E27 max 60W	AT25010PB
LUSK300/PCM	Seinävarsi kanta 300 mm pallokuvulle	musta	E27 max 60W	AT300140OPL, AT300140OPL, AT300140KB
LUSK50020	Seinävarsi kanta 200/250/300 mm	musta	E27 max 60W	



LUSK50020

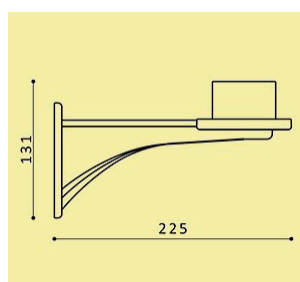

KÄPYVALAISIMIEN VARAOSAT

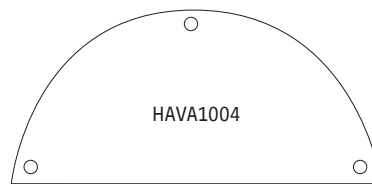
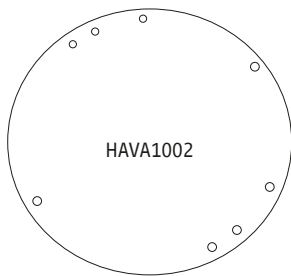

SÄHKÖNUMERO	KOODI	TUOTE	MITAT mm	SOPII TUOTTEISIIN
	HAVA1001	Käpyvalaisimen suojalevy kirkas	172x400	AT101 Käpy
	HAVA1002	Käpyvalaisimen suojakansi kirkas	Ø 160	AT101 Käpy
	HAVA1003	Käpyvalaisimen suojakansi kirkas	Ø 95	AT103 Käpy
	HAVA1004	Seinäkäpyvalaisimen suojakansi kirkas	160x80	
	HAVAKV	Sisäkäpy valkoinen	Ø 150x180	
	HAVAKH	Sisäkäpy hopea	Ø 150x180	
	HAVAKK	Sisäkäpy kupari	Ø 150x180	
	R4401K	Lasikupu kirkas	Ø 95x170	Averia, Gala-sarja
	R4401O	Lasikupu opaali	Ø 95x170	Averia, Gala-sarja
	R4405K	Lasikupu kirkas	Ø 95x240	Iso-Averia, Festivo
	R4405O	Lasikupu opaali	Ø 95x240	

LED VALONLÄHTEET E27/E40

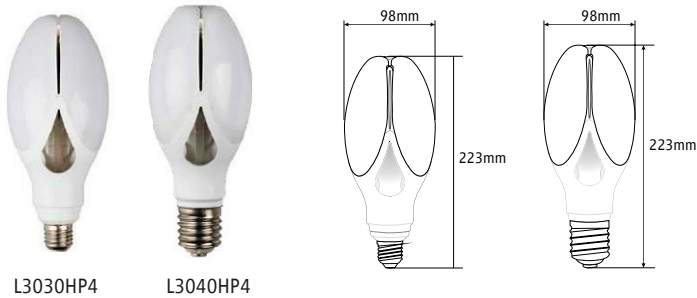

L3030HP4

L3040HP4

KOODI	TUOTE	TEHO	KANTA	LUMEN	KELVIN	MITAT mm	
L3030HP4	Led High Power	24	E27/E40	3000	4000	Ø 98x223	Sisältää E40 adapterin
L3040HP4	Led High Power	35	E27/E40	4000	4000	Ø 98x223	Sisältää E40 adapterin



KOODI	TUOTE	TEHO	KANTA	LUMEN	KELVIN	MITAT mm	
DA6080W	Deco Led	8	E27	806	3000	Ø 60x109	
DA6080N	Deco Led	8	E27	823	4000	Ø 60x109	
DA6010W	Deco Led	11	E27	1055	3000	Ø 60x109	
DA6010N	Deco Led	11	E27	1077	4000	Ø 60x109	
DA6015W	Deco Led	15	E27	1521	3000	Ø 60x118	
DA6015N	Deco Led	15	E27	1552	4000	Ø 60x118	
DA6020W	Deco Led	16	E27	2000	3000	Ø 60x118	
DA6020N	Deco Led	16	E27	2040	4000	Ø 60x118	
A6520WW	Deco Led	16	E27	1920	3000	Ø 65x120	
A6520NW	Deco Led	16	E27	1945	4000	Ø 65x120	
A6825WW	Deco Led	19	E27	2450	3000	Ø 68x129	
A6825NW	Deco Led	19	E27	2480	4000	Ø 68x129	
DA6024W	Deco Led	19	E27	2400	3000	Ø 60x118	
DA6024N	Deco Led	19	E27	2450	4000	Ø 60x118	

Valonlähteet saatavilla 3000K – 6000K.

RESERVI-sarja

Reservi-sarja on valotehokas ja ilkvallankestävä valaisinkupusarja, joka soveltuu sisä- ja ulkovalaistukseen sekä erityisesti rakennusten numerovalaistukseen. Kupujen materiaali on polykarbonaatti tai akryyli. Reservi-sarjan valaisinkuvut soveltuvat sekä vanhoihin että uusiin kohteisiin.



Saranakuvut



AT2000

AT1500



AT2001

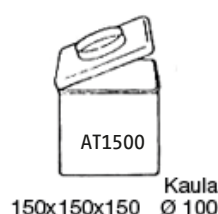

AT1500

150x150x150 Kaula Ø 100



AT200

200x200x200 Kaula Ø 100

SÄHKÖNUMERO	KOODI	TUOTE	MITAT mm	Kierre/kanta/aukko	mm	SOPII TUOTTEeseen
42 390 00	AT1500	Saranakupu	150x150x150	kaula	Ø 100	
42 390 01	AT2000	Saranakupu	200x200x200	kaula	Ø 100	
42 390 33	AT2001	Saranakupu	200x200x200	kaula	162x162 rk	BEGA 44007, 4008
	AT200E	Numerovalokupu	200x200x200	kaula	100	

Puolipallot



AT2851

AT2802

AT2950



AT2952

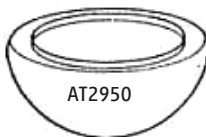

AT2950



AT2802



AT2851

300x190 Aukko Ø220 245x130 Aukko Ø150 190x100 Aukko Ø150

SÄHKÖNUMERO	KOODI	TUOTE	MITAT mm	Kierre/kanta/aukko	mm	SOPII TUOTTEeseen
42 390 17	AT2950	Puolipallo	300x190	aukko	Ø 220	Orno Bau 971/504/30
	AT2951	Puolipallo	300x145	kaulus rk	Ø 250	
	AT2952	Puolipallo	300x145	kaulus rk	Ø 200	
42 390 18	AT2802	Puolipallo	245x130	aukko	Ø 150	
	AT2853	Puolipallo	245x135	aukko	Ø 170	Orno 971-500125
42 390 19	AT2851	Puolipallo	190x100	aukko	Ø 150	
	AT2853	Puolipallo	245x135	aukko	Ø 170	
42 390 20	AT2803	Puolipallo	245x135	aukko rk	Ø 150	
	AT2855					

Neliökuvut

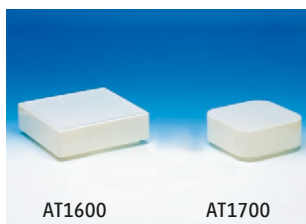

AT1600

AT1700

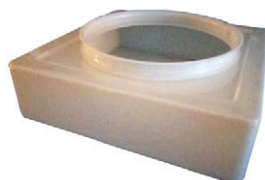

AT1602

AT1600

AT1700



290x290x90 Kaula 250x250



220x220x80 Kaula Ø190

SÄHKÖNUMERO	KOODI	TUOTE	MITAT mm	Kierre/kanta/aukko	mm	SOPII TUOTTEeseen
42 390 15	AT1600	Neliökupu	290x290x90	kaula	250x250	
42 390 34	AT1602	Neliökupu	290x290x95	kaulus rk	Ø 225	
42 390 16	AT1700	Neliökupu	220x220x80	kaula	Ø 190	

RESERVI-sarja

Linkkukuvut

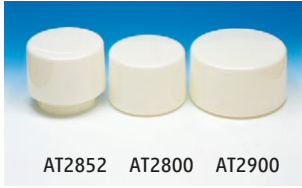

AT2852 AT2800 AT2900

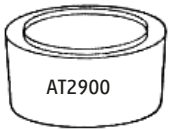

AT2900

300x135 Aukko Ø220

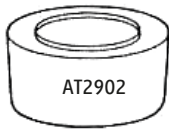

AT2902

300x135 Aukko Ø180



AT2800

240x135 Aukko Ø150



AT2850

245x130 Kierre Ø 125



AT2852

245x130 Kierre Ø 185



AT2904

300x145 Kaulus Ø 200

SÄHKÖNUMERO	KOODI	TUOTE	MITAT mm	Kierre/kanta/aukko	mm	SOPII TUOTTEESEEN
42 390 02	AT2900	Linkkukupu	300x135	aukko	Ø 220	l-valo 7202
	AT2901	Linkkukupu	300x145	kaulus rk	Ø 250	l-valo 7202
42 390 05	AT2902	Linkkukupu	300x135	aukko	Ø 180	
	AT2903	Linkkukupu	300x145	kaulus rk	Ø 220	
	AT2904	Linkkukupu	300x145	kaulus rk	Ø 200	
42 390 03	AT2800	Linkkukupu	240x135	aukko	Ø 150	
42 390 06	AT2850	Linkkukupu	245x130	kierre	Ø 125	
42 390 07	AT2852	Linkkukupu	245x130	kierre	Ø 185	
42 390 04	AT2800	Linkkukupu	245x130	aukko	Ø 150	

Lieriökuvut



AT2702 AT2700 AT2600 AT2503 AT2502



AT2702

125x145

Kierre 125

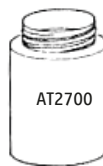

AT2700

125x145

Kierre Ø 100



AT2600

125x145

Kierre Ø 85



AT2503

80x75

Kierre Ø 60



AT2502

80x120

Kierre Ø 70



AT2751

AT2750

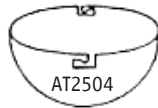

AT2504

90x50

SÄHKÖNUMERO	KOODI	TUOTE	MITAT mm	Kierre/kanta/aukko	mm	SOPII TUOTTEESEEN
42 390 08	AT2702	Lieriökupu	125x145	kierre	Ø 125	
42 390 09	AT2700	Lieriökupu	125x145	kierre	Ø 100	
42 390 10	AT2600	Lieriökupu	125x145	kierre	Ø 85	BEGA 44007, 4008
42 390 11	AT2503	Lieriökupu	80x75	kierre	Ø 60	
Vihreä	AT2504	Lieriökupu Vara	90/150	aukko	Ø 90	
42 390 12	AT2502	Lieriökupu	80x120	kierre	Ø 75	
42 390 13	AT2500	Lieriökupu	80x120	kierre	Ø 60	
42 390 14	AT2801	Lieriökupu	240x140	kanta	Ø 150 rk	
42 390 31	AT2751	Lieriökupu	200x260	kierre	Ø 125	
42 390 32	AT2750	Lieriökupu	150x240	kierre	Ø 125	

RESERVI-sarja

Pallokuvut



SÄHKÖNUMERO	KOODI	TUOTE	MITAT mm	Kierre/kanta/aukko	mm	SOPII TUOTTEeseen
42 390 21	AT2450	Pallokupu	Ø 190	kierre	100	
	AT2420	Pallokupu	Ø 200	kierre	85	
42 390 22	AT2400	Pallokupu	Ø 160	kierre	85	
42 390 23	AT2451	Pallokupu	Ø 190	kaula	100 rk	I-valo 4008/200-2
42 390 24	AT3300	Pallokupu	Ø 300	kaula	150	AT300150OP ks. sivu 3
42 390 25	AT3200	Pallokupu	Ø 300	kierre	125	AT300125K ks. sivu 3

ASUNTOVALAISIMIEN KUVUT

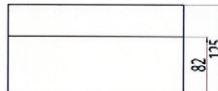
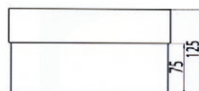
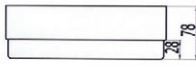
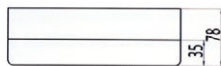
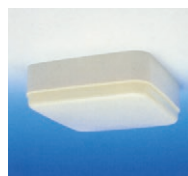
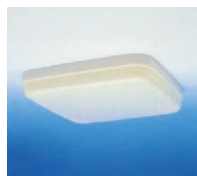

AT7829PV

AT7829NV

AT125NV

AT125PV

SÄHKÖNUMERO	KOODI	TUOTE	MITAT mm	SOPII TUOTTEISIIN
41 169 24	ATK78P	Kupu standard matala pyöreä	Ø 240x35	AT7829P, AT95P, AT43P
41 169 23	ATK78N	Kupu standard matala neliö	240x240x28	AT7829N, AT95N, AT43N
41 169 26	ATK125P	Kupu standard korkea pyöreä	Ø 240x85	AT125P
41 169 25	ATK125N	Kupu standard korkea neliö	240x240x75	AT125N
	KEHYS78P	Kehys standard matala pyöreä	Ø 240	AT7829P
	KEHYS78N	Kehys standard matala neliö	240x240	AT7829N
41 169 29	KEHYS125P	Kehys standard korkea pyöreä	Ø 240	AT125P
41 169 28	KEHYS125N	Kehys standard korkea neliö	240x240	AT125N

ASUNTOVALAISIMIEN KUVUT



SÄHKÖNUMERO	KOODI	TUOTE	MITAT mm	SOPII TUOTTEISIIN
	ALUNO375	Aluno kupu	Ø 375	
	ALUNETTE250	Alunette kupu	Ø 250	
	KUPUTITAN	Titan kupu	Ø 350	
	KUPUAVR254	AVR254 kupu	Ø	AVR25429...
HA2016/1 41 028 07	KUPUAVR12	AVR12 kupu, opaali	Ø 220/65	AVR12, Ensto AVR2/AVR2.1 41 175 40
HA2016/2	KUPUAVR12	AVR12 kupu, kirkas uritettu	Ø 220/65	AVR12, Ensto AVR2/AVR2.1 41 175 40
	HA2017/1/AVV4	AVR4 kupu, opaali		AVR4
	KUPUSOL1	Kupu, opaali matala	Ø 285	782
	KUPUSOL2	Kupu, opaali korkea	Ø 285	770
	KUPUSOL3	Kupu, opaali matala uusi	Ø 285	
	KUPUAVV7	Numerovalaisimen kupu		AVR7.1

Työpisteet

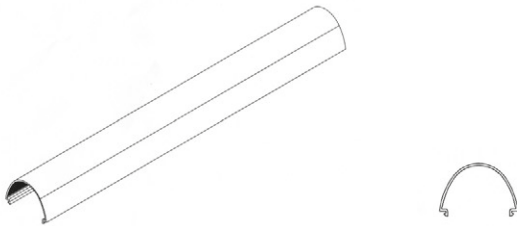

SÄHKÖNUMERO	KOODI	TUOTE	MITAT mm	SOPII TUOTTEISIIN
T8	KUAL11	Kupu työpistevalaisin T8 11W	L=330	
	KUAL14229	Kupu työpistevalaisin T8 2x9W	L=406	
	KUAL15	Kupu työpistevalaisin T8 15W	L=470	
	KUAL18	Kupu työpistevalaisin T8 18W	L=623	
	KUAL36	Kupu työpistevalaisin T8 36W	L=1232	
	KUAL58	Kupu työpistevalaisin T8 58W	L=1531	
T5	KUAL14	Kupu työpistevalaisin T5 14W	L=579	
	KUAL21	Kupu työpistevalaisin T5 21W	L=879	
	KUAL28	Kupu työpistevalaisin T5 28W	L=1179	
	KUAL35/49	Kupu työpistevalaisin T5 49W	L=1479	
Vanha	L13218	Kupu työpistevalaisin 18W	L=613	
	L13236	Kupu työpistevalaisin 36W	L=1215	
	KU320	Kupu työpistevalaisin 11W	L=285	AVR17

LED-putket T8



Sisältää
syttytimen







KOODI	TUOTE	TEHO	KANTA	LUMEN	KELVIN	MITAT mm	LED >LOISTEPUTKI
L18840VB	LED-putki T8	9	G13	1060	4000	26x600	9W > 18W
L36840VB	LED-putki T8	18	G13	2050	4000	26x1200	18W > 36W
L58840VB	LED-putki T8	24	G13	2500	4000	26x1500	24W > 58W

Valonlähteet saatavilla 3000K – 6000K.

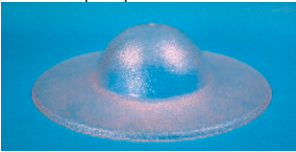





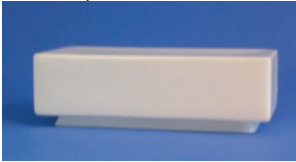

MUUT VALAISINKUVUT

Vakiokupumallistomme lisäksi valmistamme muovista valaisimien varaosia ja valaisinkupuja toimittamienne mittapiirustusten tai mallin mukaan. Tarjouslaskentamme tekee teille tarjouksen.

Tarjousta varten tarvitsemme: mitat, arvotarran tiedot, mallikappaleen ja kappalemäärän.

KOODI	TUOTE	VÄRI	MITAT mm L x S x K	Kierre/aukko/ bajonetti	mm	SOPII TUOTTEESEEN	SÄHKÖNUMERO
HA1001	Valaisinkupu Orno Pori 	opaali	400/90		Ø 400		45 147 38
HA1001/2	Valaisinkupu Opno Pori 	kirkas	400/90		Ø 400		
HA1002	Valaisinkupu Orno Agent 	opaali	250/120	aukko	Ø 250	Orno 007	42 390 26
HA1003	Valaisinkupu Alfa 	opaali	225/95	aukko	Ø 225	Glamox	
HA1004	Valaisinkupu Stradalux 	kirkas	345/90	aukko	Ø 345		
HA1005	Valaisinkupu Orno Panssarinyrkki 	kirkas	540/145/230	aukko kanta	Ø 345 Ø 145		
HA1006	Valaisinkupu Orno 5395/Z 	kirkas	125x280/65	aukko	Ø 125 x 280		42 390 28
HA1007	Valaisinkupu 	opaali	280/100	aukko	Ø 280		

MUUT VALAISINKUVUT

KOODI	TUOTE	VÄRI	MITAT mm L x S x K	Kierre/aukko/ bajonetti	mm	SOPII TUOTTEESEEN	SÄHKÖNUMERO
HA1008	Valaisinkupu 	opaali	300/220/115	kaula	Ø 220		
HA1011	Valaisinkupu 	opaali	140x290x90	aukko	100x 250	I-valo 4043-140	41 169 20
HA1012	Valaisinkupu 	opaali	400/300/90	aukko	Ø 300	I-VALO 4046-400	
HA1013	Valaisinkupu 	opaali	300/220/135	aukko	Ø 220/200		
HA2013/1	Valaisinkupu 	opaali alaosa/ kirkas yläosa/ opaali	600/2x140/350	aukko	Ø 2x140		
HA1013/2	Valaisinkupu 	opaali alaosa/ kirkas yläosa/ opaali	600/13/195/350	aukko	Ø 13 ja 195		
HA1021/1	Valaisinkupu 	opaali	210/200/90	aukko	Ø 200	I-valo 4046-200	45 147 39
HA2008/1	Valaisinkupu 	kirkas	360/330/160	aukko	Ø 330		
HA2008/2	Valaisinkupu 	opaali	195/195/60	aukko	195 x 195		

MUUT VALAISINKUVUT

KOODI	TUOTE	VÄRI	MITAT mm L x S x K	Kierre/aukko/ bajonetti	mm	SOPII TUOTTEESEEN	SÄHKÖNUMERO
HA2008/3	Valaisinkupu 	opaali	240/150/240	aukko	Ø 150		42 390 29
HA2008/4	Valaisinkupu Glamox 	opaali	215/198/87	aukko	Ø 198		
HA2008/5	Valaisinkupu 	opaali	300/270/90	aukko	Ø 270	I-VALO 4046-300	
HA2008/6	Valaisinkupu 	opaali	270/ h110	aukko	Ø 230		42 390 30
HA2013/2	Valaisinkupu 	prisma	1454/139/3			HAMG-261.20	
HA2013/3	Valaisinkupu 	kirkas	375		Ø 375		
HA2013/4	Valaisinkupu neliö 2 reikää sivussa 	opaali	290/290/90	kaula 250x250			
HA2013/5	Valaisinkupu 	prisma tai opaali	1454/203/1				

MUUT VALAISINKUVUT

KOODI	TUOTE	VÄRI	MITAT mm L x S x K	Kierre/aukko/ bajonetti	SOPII TUOTTEESEEN	SÄHKÖNUMERO
LU77	Valaisinkupu 	opaali	297x150		150	
HA2016/4K	Pylväsvalaisinkupu 	kirkas	Ø210mm/ h170mm	ruuvikiinnitys 3 reikää	Ø210	AVS70/71/73/74 45 147 40
HA2017/1/AVV4	Valaisinkupu AVR 4 valaisimille 	opaali	Ø260mm/ h115mm	3 hahloa sivulla		AVR4
HA2017/2/BAU	Valaisinkupu Orno Bau sarjaan 	opaali	Ø240mm/h130	aukko	Ø220	Bau 5574 5575 5576
HA2018/1TUN	Tunnelikupu kirkas 	kirkas	390x200 h 100			I-valo
HA2018/ KATARINA/KI HA2018/ KATARINA/OP	Kupu KATARINA-valaisimeen 	kirkas opaali	Ø150mm h300			Elektroskandia/ Rexel 45 207 50
HA2018/ NUMERO	Numerovalaisimen kupu 	opaali	200x210			Idman 1400/060
AT2020/2	Lieriökupu 	satiiniopaali	Ø 80x195	kierre	Ø 60	Massive Monaco





– Valaisinkuvut kiinteistöhoitoon! –

Luminum®

Toimisto ja tuotanto sijaitsevat Vihdin Nummelassa
hyvien liikenneyhteyksien varrella, pääkaupunkiseudun kupeessa.

Sinua palvelevat paikalliset myyntiedustajamme sekä
verkkokauppa luminum.fi.