



LABORATORY FURNACES



Facts

- Production of laboratory and industrial furnaces since 1947
- Production site in Lilienthal/Bremen - Made in Germany
- 500 employees worldwide
- 150,000 customers in more than 100 countries
- Very wide product range of furnaces
- One of the biggest R&D departments in the furnace industry
- High vertical integration

Global Sales and Service Network

- Manufacturing only in Germany
- Decentralized sales and service close to the customer
- Own sales organization and long term sales partners in all important world markets
- Individual on-site customer service and consultation
- Fast remote maintenance options for complex furnaces
- Reference customers with similar furnaces or systems close to you
- Secured spare parts supply, many spare parts available from stock
- Further information see page 78

Setting Standards in Quality and Reliability

- Project planning and construction of tailor-made thermal process plants incl. material handling and charging systems
- Innovative controls and automation technology, adapted to customer needs
- Very reliable and durable furnace systems
- Customer test center for process assurance

Experience in Thermal Processing

- Thermal Process Technology
- Advanced Materials
- Fiber Optics/Glass
- Foundry
- Laboratory
- Dental
- Arts & Crafts

Table of Contents



Ovens and Forced Convection Furnaces up to 850 °C

| | |
|---|----|
| Ovens up to 300 °C | 6 |
| Chamber ovens up to 260 °C | 8 |
| Forced convection chamber furnaces up to 850 °C | 10 |

Muffle Furnaces up to 1400 °C

| | |
|--|----|
| Muffle furnaces up to 1200 °C | 14 |
| Economy muffle furnaces up to 1100 °C | 16 |
| Muffle furnaces with brick insulation up to 1300 °C | 17 |
| Muffle furnaces up to 1400 °C | 18 |
| Muffle furnaces with embedded heating elements up to 1100 °C | 19 |
| Ashing furnaces up to 1100 °C | 20 |
| Ashing furnaces with integrated exhaust gas cleaning up to 1100 °C | 22 |
| Weighing furnaces up to 1200 °C | 23 |
| Exhaust systems/accessories for muffle furnaces | 24 |

Chamber Furnaces up to 1400 °C

| | |
|--|----|
| Chamber furnaces up to 1400 °C | 28 |
| Chamber furnaces up to 1280 °C | 30 |
| Accessories for the heat treatment of metals | 31 |

High-Temperature Furnaces up to 1800 °C

| | |
|---|----|
| High-temperature furnaces with SiC rod heating table-top model up to 1600 °C | 34 |
| High-temperature furnaces MoSi ₂ heating elements table-top model up to 1800 °C | 35 |
| High-temperature bottom loading furnaces up to 1700 °C | 36 |
| High-temperature furnaces with scale up to 1750 °C | 37 |
| High-temperature furnaces MoSi ₂ heating elements floor-standing model up to 1800 °C | 38 |
| High-temperature furnaces with SiC rod heating floor-standing model up to 1550 °C | 40 |
| High-temperature furnaces with MoSi ₂ heating elements with refractory brick insulation up to 1700 °C | 41 |

Tube Furnaces up to 1800 °C

| | |
|--|----|
| Compact tube furnaces up to 1300 °C | 44 |
| Split-type tube furnaces for horizontal or vertical operation up to 1300 °C | 46 |
| Rotary tube furnaces for batch operation up to 1100 °C | 48 |
| Rotary hearth furnaces for processes with continuous movement up to 1300 °C | 50 |
| Tube furnaces with stand for horizontal and vertical operation up to 1500 °C | 52 |
| High-temperature tube furnaces with SiC rod heating up to 1500 °C | 53 |
| High-temperature tube furnaces for horizontal or vertical operation up to 1800 °C | 54 |
| Working tubes | 56 |
| Gas supply systems/vacuum operation | 58 |
| Control alternatives for tube furnaces | 62 |
| Customized tube furnaces | 63 |

Furnaces for Special Applications

| | |
|---|----|
| Fire assay/cupellation furnaces up to 1300 °C | 66 |
| Gradient or lab strand annealing furnaces up to 1300 °C | 68 |
| Fast-firing furnaces up to 1300 °C | 69 |
| Laboratory melting furnaces up to 1400 °C | 70 |

Process Control and Documentation

| | |
|--|----|
| Temperature uniformity and system accuracy | 71 |
| Nabertherm Controller Series 500 | 74 |
| MyNabertherm App for Mobile Monitoring of Process Progress | 76 |
| Functions of the standard controllers | 78 |
| Process Data Storage and Data Input via PC | 79 |
| PLC Controls - HiProSystems | 81 |
| Process Data Storage | 82 |
| Nabertherm Control Center NCC | 83 |

Ovens and Forced Convection Furnaces up to 850 °C

Furnaces with forced air circulation, resulting in a very good temperature uniformity



Dual shell housing made of textured stainless steel sheets with additional fan cooling for low surface temperature



Solid state relays provide for lownoise operation



Exclusive use of insulation materials without categorization according to EC Regulation No 1272/2008 (CLP). This explicitly means that alumino silicate wool, also known as “refractory ceramic fiber” (RCF), which is classified and possibly carcinogenic, is not used.



NTLog Basic for Nabertherm controller: recording of process data with USB-flash drive



Defined application within the constraints of the operating instructions



As additional equipment: Process control and documentation via VCD software package for monitoring, documentation and control



| Furnace Group | Model | Page |
|---|-------|------|
| Ovens up to 300 °C | TR | 6 |
| Chamber ovens up to 260 °C | KTR | 8 |
| Forced convection chamber furnaces up to 850 °C | NA | 10 |

Ovens up to 300 °C, also with Safety Technology According to EN 1539

With their maximum working temperature of up to 300 °C and forced air circulation, the ovens achieve a very good temperature uniformity. They can be used for various applications such as e.g. drying, sterilizing or warm storing. Short delivery times from stock are ensured for standard models.



Oven TR 240



Oven TR 450

Standard Equipment

- Tmax 300 °C
- Working temperature range: + 20 °C above room temperature up to 300 °C
- Ovens TR 30 - TR 420 designed as tabletop models
- Ovens TR 450 - TR 1050 designed as floor standing models
- Horizontal forced air circulation results in temperature uniformity according to DIN 17052-1 better than ± 5 °C in the empty oven (with closed exhaust air flap) see page 71
- Stainless steel furnace housing, material no. 1.4016 (DIN)
- Stainless steel chamber, alloy 304 (AISI)/(DIN material no. 1.4301), rust-resistant and easy to clean
- Charging in multiple layers possible using removeable grids (number of removeable grids included, see table to the right)
- Large, wide-opening swing door, hinged on the right with quick release for models TR 30 - TR 240 and TR 450
- Double swing door with quick release for models TR 420, TR 800 and TR 1050
- Ovens TR 800 and TR 1050 equipped with transport castors
- Infinitely adjustable exhaust at the rear wall with operation from the front
- PID microprocessor control with self-diagnosis system
- Models TR ..LS: Safety technology according to EN 1539 for charges containing liquid solvents, achievable temperature uniformity ± 8 °C according to DIN 17052-1 in the empty oven (with closed exhaust air flap) see page 71
- Controller R7 (resp. C550 for TR ..LS), alternative programmable controllers see page 78

Additional Equipment

- Over-temperature limiter with adjustable cutout temperature as temperature limiter to protect the oven and load
- Fan speed of the air circulation fan can be reduced infinitely
- Window for charge observing
- Further removeable grids with rails
- Side inlet
- Electrical rotary device (associated sample holder will be individually adapted to the charge)
- Exhaust air duct DN 80
- Transport castors for models TR 240 - TR 450
- Upgrading available to meet the quality requirements of AMS2750F or FDA



Oven TR 420



Oven TR 1050 with double door

| Model | Tmax in °C | Inner dimensions in mm | | | Volume in l | Outer dimensions ¹ in mm | | | Connected load in kW | Electrical connection* | Weight in kg | Minutes to Tmax ² | Grids included | Grids max. | Max. total load ³ |
|-----------|---------------|------------------------|-----|------|----------------|-------------------------------------|-----|------|-------------------------|---------------------------|-----------------|---------------------------------|-------------------|---------------|---------------------------------|
| | | w | d | h | | W | D | H | | | | | | | |
| TR 30 | 300 | 360 | 300 | 300 | 30 | 610 | 570 | 665 | 2.1 | 1-phase | 45 | 25 | 1 | 4 | 80 |
| TR 60 | 300 | 450 | 390 | 350 | 60 | 700 | 610 | 710 | 3.1 | 1-phase | 90 | 25 | 1 | 4 | 120 |
| TR 60 LS | 260 | 450 | 360 | 350 | 60 | 700 | 820 | 710 | 5.3 | 3-phase | 100 | 25 | 1 | 4 | 120 |
| TR 120 | 300 | 650 | 390 | 500 | 120 | 900 | 610 | 860 | 3.1 | 1-phase | 120 | 45 | 2 | 7 | 150 |
| TR 120 LS | 260 | 650 | 360 | 500 | 120 | 900 | 820 | 870 | 6.3 | 3-phase | 120 | 45 | 2 | 7 | 150 |
| TR 240 | 300 | 750 | 550 | 600 | 240 | 1000 | 780 | 970 | 3.1 | 1-phase | 165 | 60 | 2 | 8 | 150 |
| TR 240 LS | 260 | 750 | 530 | 600 | 240 | 1000 | 990 | 970 | 6.3 | 3-phase | 180 | 60 | 2 | 8 | 150 |
| TR 420 | 300 | 1300 | 550 | 600 | 420 | 1550 | 815 | 970 | 6.3 | 3-phase | 250 | 60 | 2 | 8 | 200 |
| TR 450 | 300 | 750 | 550 | 1100 | 450 | 1000 | 780 | 1470 | 6.3 | 3-phase | 235 | 60 | 3 | 15 | 180 |
| TR 450 LS | 260 | 750 | 530 | 1100 | 450 | 1000 | 990 | 1470 | 12.6 | 3-phase | 250 | 60 | 3 | 15 | 180 |
| TR 800 | 300 | 1200 | 670 | 1000 | 800 | 1470 | 970 | 1520 | 6.3 | 3-phase | 360 | 80 | 3 | 10 | 250 |
| TR 1050 | 300 | 1200 | 670 | 1400 | 1050 | 1470 | 970 | 1920 | 9.3 | 3-phase | 450 | 80 | 4 | 14 | 250 |

¹External dimensions vary when furnace is equipped with additional equipment. Dimensions on request

²In the empty and closed oven, connected to 230 V 1/N/PE resp. 400 V 3/N/PE

³Max load per layer 30 kg

*Please see page 75 for more information about supply voltage



Oven TR 30 with observation window



Extricable metal grids to load the oven in different layers



Electrical rotating device (in this case with tailored platform for PARR autoclave containers)

Chamber Ovens up to 260 °C

The chamber ovens of the KTR range can be used for complex drying processes and heat treatment of charges to an application temperature of 260 °C. The high-performance air circulation enables optimum temperature uniformity throughout the work space. A wide range of accessories allow the chamber ovens to be modified to meet specific process requirements.



Chamber oven KTR 4500

Standard Equipment

- Tmax 260 °C
- Electrically heated (via a heating register with integrated chrome steel heating elements) or gas-fired (direct or indirect gas-fired including injection of the hot air into the intake duct)
- Temperature uniformity up to ± 3 °C according to DIN 17052-1 (for design without track cutouts) see page 71
- High-quality mineral wool insulation provides for outer temperatures of < 25 °C above room temperature
- High air exchange for fast drying processes
- Double-wing door for furnaces KTR 2300 and larger
- Over-temperature limiter with adjustable cutout temperature as temperature limiter to protect the oven and load
- Incl. floor insulation
- Controller B500 (5 programs with each 4 segments), alternative controllers see page 78



Chamber oven KTR 1500 with charging cart

Additional Equipment

- Track cutouts for level drive-in of charging cart
- Base frame to charge the oven via a charging forklift
- Additional Door in the back for charging from both sides or to use the oven as lock between two rooms
- Fan system for faster cooling with manual or motorized control of the exhaust flaps
- Programmed opening and closing of exhaust air flaps
- Air circulation with speed control, recommendable for processes with light or sensitive charge
- Observation window and furnace chamber lighting
- Charging cart with or without rack system
- Process control and documentation via VCD software package or Nabertherm Control Center (NCC) for monitoring, documentation and control see page 80/83



Chamber oven KTR 22500/S with chamber lightning and drive-in tracks with insulated plugs which provide for an optimal temperature uniformity

| Model | Tmax °C | Inner dimensions in mm | | | Volume in l | Outer dimensions ² in mm | | | Heating power in kW ¹ | Electrical connection* |
|-----------|------------|------------------------|------|------|----------------|-------------------------------------|------|------|-------------------------------------|---------------------------|
| | | w | d | h | | W | D | H | | |
| KTR 1000 | 260 | 1000 | 1000 | 1000 | 1000 | 1820 | 1430 | 1890 | 18 | 3-phase |
| KTR 1500 | 260 | 1000 | 1000 | 1500 | 1500 | 1820 | 1430 | 2390 | 18 | 3-phase |
| KTR 2000 | 260 | 1100 | 1500 | 1200 | 2000 | 1920 | 1930 | 2090 | 18 | 3-phase |
| KTR 2300 | 260 | 1250 | 1250 | 1500 | 2300 | 2120 | 1680 | 2460 | 27 | 3-phase |
| KTR 3100 | 260 | 1250 | 1250 | 2000 | 3100 | 2120 | 1680 | 2960 | 27 | 3-phase |
| KTR 3400 | 260 | 1500 | 1500 | 1500 | 3400 | 2370 | 1930 | 2460 | 45 | 3-phase |
| KTR 4500 | 260 | 1500 | 1500 | 2000 | 4500 | 2370 | 1930 | 2960 | 45 | 3-phase |
| KTR 4600 | 260 | 1750 | 1750 | 1500 | 4600 | 2620 | 2175 | 2480 | 45 | 3-phase |
| KTR 6000 | 260 | 2000 | 2000 | 1500 | 6000 | 2870 | 2430 | 2460 | 54 | 3-phase |
| KTR 6125 | 260 | 1750 | 1750 | 2000 | 6125 | 2620 | 2175 | 2980 | 45 | 3-phase |
| KTR 6250 | 260 | 1250 | 2500 | 2000 | 6250 | 2120 | 3035 | 2960 | 54 | 3-phase |
| KTR 8000 | 260 | 2000 | 2000 | 2000 | 8000 | 2870 | 2430 | 2960 | 54 | 3-phase |
| KTR 9000 | 260 | 1500 | 3000 | 2000 | 9000 | 2490 | 3870 | 2920 | 72 | 3-phase |
| KTR 12300 | 260 | 1750 | 3500 | 2000 | 12300 | 2620 | 4350 | 2980 | 90 | 3-phase |
| KTR 13250 | 260 | 1250 | 5000 | 2000 | 13250 | 2120 | 6170 | 2960 | 108 | 3-phase |
| KTR 16000 | 260 | 2000 | 4000 | 2000 | 16000 | 2870 | 4850 | 2960 | 108 | 3-phase |
| KTR 21300 | 260 | 2650 | 3550 | 2300 | 21300 | 3600 | 4195 | 3380 | 108 | 3-phase |
| KTR 22500 | 260 | 2000 | 4500 | 2500 | 22500 | 3140 | 5400 | 3500 | 108 | 3-phase |

¹Depending on furnace design connected load might be higher

²External dimensions vary when furnace is equipped with additional equipment. Dimensions on request.

*Please see page 75 for more information about supply voltage



Drive-in tracks with sealing shoes



Charging cart with pull-out trays



Pull-out shelves, running on rolls

High-Temperature Ovens, Forced Convection Chamber Furnaces up to 850 °C

These chamber furnaces with air circulation are characterized by their extremely high temperature uniformity. Hence, they are especially suitable for processes such as annealing, crystalizing, preheating, curing, but also for numerous processes in tool making. Due to the modular concept, the forced convection furnaces can be adjusted to the process requirements by adding suitable equipment.



Forced convection chamber furnace NAT 15/65 as table-top model

Standard Equipment

- Tmax 450 °C, 650 °C, or 850 °C
- Horizontal air circulation with optimum distribution through stainless steel baffles
- Swing door hinged on the right
- Temperature uniformity up to ± 4 °C according to DIN 17052-1 (NAT 15/65 and NAT 30/85 up to ± 5 °C) in the empty work space see page 71
- One frame sheet and rails for two additional trays included in the scope of delivery (NAT 15/65 and NAT 30/85 without frame sheet)
- Base frame included in the delivery, NAT 15/65 and NAT 30/85 designed as table-top model
- Controller B500/B510 (5 programs with each 4 segments), alternative controllers see page 78



Forced convection chamber furnace NA 30/65 with manual lift door and protective gas box

Additional Equipment (not for Model NAT 15/65 and NAT 30/85)

- Optimization of the temperature uniformity up to ± 3 °C according to DIN 17052-1 in the empty work space see page 71
- Air inlet and exhaust air flaps when used for drying
- Controlled fan assisted cooling
- Manual lift door (up to model NA 120/..)
- Pneumatic lift door
- Air circulation with speed control, recommendable for processes with light or sensitive charge
- Additional frame sheet
- Gas supply boxes different charging methods
- Feed and charging aids
- Charge control with documentation of the charge thermocouple



Forced convection chamber furnace NA 120/45



Forced convection chamber furnace NA 250/85

| Model | Tmax in °C | Inner dimensions in mm | | | Volume in l | Outer dimensions ³ in mm | | | Connected load in kW | Electrical connection* | Weight in kg |
|------------------------|---------------|------------------------|------|-----|----------------|-------------------------------------|------|------|-------------------------|---------------------------|-----------------|
| | | w | d | h | | W | D | H | | | |
| NA 30/45 | 450 | 290 | 420 | 260 | 30 | 1040 | 1290 | 1385 | 3.6 | 1-phase | 285 |
| NA 60/45 | 450 | 350 | 500 | 350 | 60 | 1100 | 1370 | 1475 | 6.6 | 3-phase | 350 |
| NA 120/45 | 450 | 450 | 600 | 450 | 120 | 1250 | 1550 | 1550 | 9.8 | 3-phase | 460 |
| NA 250/45 | 450 | 600 | 750 | 600 | 250 | 1350 | 1650 | 1725 | 12.8 | 3-phase | 590 |
| NA 500/45 | 450 | 750 | 1000 | 750 | 500 | 1550 | 1900 | 1820 | 18.8 | 3-phase | 750 |
| NA 675/45 | 450 | 750 | 1200 | 750 | 675 | 1550 | 2100 | 1820 | 25.0 | 3-phase | 900 |
| NAT 15/65 ¹ | 650 | 295 | 340 | 170 | 15 | 470 | 790 | 460 | 3.3 | 1-phase | 60 |
| NA 30/65 | 650 | 290 | 420 | 260 | 30 | 870 | 1290 | 1385 | 7.0 | 3-phase ² | 285 |
| NA 60/65 | 650 | 350 | 500 | 350 | 60 | 910 | 1390 | 1475 | 9.0 | 3-phase | 350 |
| NA 120/65 | 650 | 450 | 600 | 450 | 120 | 990 | 1470 | 1550 | 13.0 | 3-phase | 460 |
| NA 250/65 | 650 | 600 | 750 | 600 | 250 | 1170 | 1650 | 1680 | 21.0 | 3-phase | 590 |
| NA 500/65 | 650 | 750 | 1000 | 750 | 500 | 1290 | 1890 | 1825 | 28.0 | 3-phase | 750 |
| NA 675/65 | 650 | 750 | 1200 | 750 | 675 | 1290 | 2100 | 1825 | 28.0 | 3-phase | 900 |
| NAT 30/85 ¹ | 850 | 320 | 320 | 300 | 30 | 825 | 670 | 750 | 3.3 | 1-phase | 100 |
| NA 60/85 | 850 | 350 | 500 | 350 | 60 | 790 | 1330 | 1440 | 11.0 | 3-phase | 315 |
| NA 120/85 | 850 | 450 | 600 | 450 | 120 | 890 | 1420 | 1540 | 14.0 | 3-phase | 390 |
| NA 250/85 | 850 | 600 | 750 | 600 | 250 | 1120 | 1690 | 1810 | 23.0 | 3-phase | 840 |
| NA 500/85 | 850 | 750 | 1000 | 750 | 500 | 1270 | 1940 | 1960 | 34.0 | 3-phase | 1150 |
| NA 675/85 | 850 | 750 | 1200 | 750 | 675 | 1270 | 2190 | 1960 | 34.0 | 3-phase | 1300 |

¹Table-top model

²Heating only between two phases

³External dimensions vary when furnace is equipped with additional equipment. Dimensions on request.

*Please see page 75 for more information about supply voltage



Port for thermocouple



Tray



Roller conveyor in furnace chamber

Muffle Furnaces up to 1400 °C

Muffle furnaces are the reliable and long-lasting all-rounders in the laboratory and are ideally suited for a large number of processes in the field of material research and heat treatment.



Dual shell housing made of textured stainless steel sheets with additional fan cooling for low surface temperature



Solid state relays provide for lownoise operation



Exclusive use of insulation materials without categorization according to EC Regulation No 1272/2008 (CLP). This explicitly means that alumino silicate wool, also known as “refractory ceramic fiber” (RCF), which is classified and possibly carcinogenic, is not used.



NTLog Basic for Nabertherm controller: recording of process data with USB-flash drive



Defined application within the constraints of the operating instructions



As additional equipment: Process control and documentation via VCD software package for monitoring, documentation and control



| Furnace Group | Model | Page |
|--|-------------|------|
| Muffle furnaces up to 1100 °C or 1200 °C | L(T) | 14 |
| Economy muffle furnaces up to 1100 °C | LE | 16 |
| Muffle furnaces with brick insulation up to 1300 °C | L(T) ../13 | 17 |
| Muffle furnaces up to 1400 °C | L(T) ../14 | 18 |
| Muffle furnaces with embedded heating elements in the ceramic muffle up to 1100 °C | L(T) ../SKM | 19 |
| Ashing furnaces up to 1100 °C | LV(T) | 20 |
| Ashing furnaces up to 1100 °C with integrated exhaust gas cleaning | L ../BO | 22 |
| Weighing furnaces up to 1200 °C | L(T) ../SW | 23 |
| Exhaust systems/accessories for muffle furnaces | | 24 |

Muffle Furnaces up to 1100 °C or 1200 °C

The muffle furnaces L 1/12 - LT 40/12 have been proven for daily laboratory use. These models stand out for their excellent workmanship, advanced and attractive design, and high level of reliability. The muffle furnaces come equipped with either a flap door or lift door at no extra charge.



Muffle furnace LT 5/12 with lift door

Standard Equipment

- Tmax 1100 °C or 1200 °C
- Heating from two sides by ceramic heating plates (heating from three sides for muffle furnaces L 24/11 - LT 40/12) for an optimal temperature uniformity see page 71
- Thermocouple type N (1100 °C) or type S (1200 °C)
- Ceramic heating plates with integral heating element which is safeguarded and easy to replace
- Optional flap door (L) which can be used as work platform or lift door (LT) with hot surface facing away from the operator
- Adjustable air inlet integrated in door (see illustration)
- Exhaust air outlet in rear wall of furnace
- Controller B510 resp. R7 for L 1/12 (5 programs with each 4 segments), alternative controllers see page 78



Muffle furnace L 3/11 with flap door

Additional Equipment

- Chimney, chimney with fan or catalytic converter (not for L 1 and L 15) see page 24
- Over-temperature limiter with adjustable cutout temperature as temperature limiter to protect the oven and load
- Protective gas connection to purge with non-flammable protective or reaction gases (not available in combination with chimney, chimney with fan or catalytic converter) not gas tight
- Manual or automatic gas supply system
- Port for thermocouple in the rear wall or in the furnace door
- Charging rack with closed or perforated trays for loading the furnace in two levels incl. holder for inserting/removing the trays up to a max. temperature of 800°C and a max. loading weight of 2 kg for the L(T) 9/11 respectively 3 kg for the L(T) 15/11
- Please see page 25 for more accessories



Muffle furnace L 3/12



Muffle furnace L 3/11 with flap door

| Model | Tmax in °C ¹ | Inner dimensions in mm | | | Volume in l | Outer dimensions ² in mm | | | Temperature uniformity of +/- 5K in the empty workspace ⁵ | | | Connected load in kW | Electrical connection* | Weight in kg | Heating time in min ⁴ |
|------------|----------------------------|------------------------|-----|-----|----------------|-------------------------------------|-----|----------------|--|-----|-----|----------------------------|---------------------------|-----------------|--|
| | | w | d | h | | W | D | H ³ | w | d | h | | | | |
| L(T) 3/11 | 1100 | 160 | 140 | 100 | 3 | 385 | 330 | 405+155 | 110 | 50 | 50 | 1.2 | 1-phase | 20 | 40 |
| L(T) 5/11 | 1100 | 200 | 170 | 130 | 5 | 385 | 390 | 460+205 | 170 | 80 | 90 | 2.4 | 1-phase | 30 | 50 |
| L(T) 9/11 | 1100 | 230 | 240 | 170 | 9 | 415 | 455 | 515+240 | 180 | 150 | 120 | 3.0 | 1-phase | 35 | 65 |
| L(T) 15/11 | 1100 | 230 | 340 | 170 | 15 | 415 | 555 | 515+240 | 180 | 250 | 120 | 3.2 | 1-phase | 40 | 75 |
| L(T) 24/11 | 1100 | 280 | 340 | 250 | 24 | 490 | 555 | 580+320 | 230 | 250 | 200 | 4.5 | 3-phase | 55 | 70 |
| L(T) 40/11 | 1100 | 320 | 490 | 250 | 40 | 530 | 705 | 580+320 | 270 | 400 | 200 | 6.0 | 3-phase | 65 | 75 |
| L 1/12 | 1200 | 90 | 115 | 110 | 1 | 290 | 280 | 430 | 45 | 60 | 40 | 1.5 | 1-phase | 10 | 25 |
| L(T) 3/12 | 1200 | 160 | 140 | 100 | 3 | 385 | 330 | 405+155 | 110 | 50 | 50 | 1.2 | 1-phase | 20 | 45 |
| L(T) 5/12 | 1200 | 200 | 170 | 130 | 5 | 385 | 390 | 460+205 | 170 | 80 | 90 | 2.4 | 1-phase | 30 | 60 |
| L(T) 9/12 | 1200 | 230 | 240 | 170 | 9 | 415 | 455 | 515+240 | 180 | 150 | 120 | 3.0 | 1-phase | 35 | 75 |
| L(T) 15/12 | 1200 | 230 | 340 | 170 | 15 | 415 | 555 | 515+240 | 180 | 250 | 120 | 3.2 | 1-phase | 40 | 85 |
| L(T) 24/12 | 1200 | 280 | 340 | 250 | 24 | 490 | 555 | 580+320 | 230 | 250 | 200 | 4.5 | 3-phase | 55 | 80 |
| L(T) 40/12 | 1200 | 320 | 490 | 250 | 40 | 530 | 705 | 580+320 | 270 | 400 | 200 | 6.0 | 3-phase | 65 | 85 |

¹Recommended working temperature for processes with longer dwell times is 1000 °C (L../11) resp. 1100 °C (L../12)

*Please see page 75 for more information about supply voltage

²External dimensions vary when furnace is equipped with additional equipment. Dimensions on request.

³Including opened lift door (LT models)

⁴Heating time of the empty and closed furnace up to Tmax - 100 K (connected to 230 V 1/N/PE resp. 400 V 3/N/PE)

⁵Temperature uniformity of +/- 5 K with closed fresh-air inlet in empty work space according to DIN 17052-1 at working temperatures above 800 °C see page 71



Chimney with fan

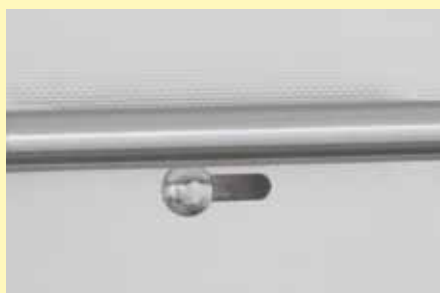

Adjustable air inlet integrated in the door



Gas supply system for non-flammable protective or reactive gas

Economy Muffle Furnaces up to 1100 °C

With their convincing price/performance ratio and the fast heat-up rates, these compact muffle furnaces are perfect for many applications in the laboratory. Quality features like the dual shell furnace housing of rust-free stainless steel, their compact, lightweight constructions, or the heating elements encased in quartz glass tubes make these models reliable partners for your application.



Muffle furnace LE 6/11

Standard Equipment

- Tmax 1100 °C
- Heating from two sides from heating elements protected in quartz glass tubes
- Fast heating times (see table)
- Maintenance-friendly replacement of heating elements and insulation
- Housing coated in RAL
- Flap door which can also be used as a work platform
- Exhaust air outlet in rear wall
- Compact dimensions and light weight
- Controller mounted under the door to save space
- Controller R7, controls description see page 78

Additional Equipment

- Chimney, chimney with fan or catalytic converter (not for LE 1 and LE 2) see page 24
- Please see page 25 for more accessories

| Model | Tmax in °C ¹ | Inner dimensions in mm | | | Volume in l | Outer dimensions ² in mm | | | Temperature uniformity of +/- 5K in the empty works- pace ⁴ | | | Connected load in kW | Electrical connection* | Weight in kg | Heating time in min ³ |
|----------|----------------------------|------------------------|-----|-----|----------------|-------------------------------------|-----|-----|--|-----|-----|-------------------------|---------------------------|-----------------|--|
| | | w | d | h | | W | D | H | w | d | h | | | | |
| LE 1/11 | 1100 | 90 | 115 | 110 | 1 | 290 | 280 | 410 | 40 | 65 | 60 | 1,6 | 1-phase | 15 | 10 |
| LE 2/11 | 1100 | 110 | 180 | 110 | 2 | 330 | 390 | 410 | 60 | 130 | 60 | 1,9 | 1-phase | 20 | 15 |
| LE 6/11 | 1100 | 170 | 200 | 170 | 6 | 390 | 440 | 470 | 120 | 150 | 120 | 2,0 | 1-phase | 27 | 30 |
| LE 14/11 | 1100 | 220 | 300 | 220 | 14 | 440 | 540 | 520 | 170 | 250 | 170 | 3,2 | 1-phase | 35 | 35 |
| LE 24/11 | 1100 | 260 | 330 | 280 | 24 | 490 | 570 | 590 | 200 | 270 | 230 | 3,5 | 1-phase | 42 | 40 |

¹Recommended working temperature for processes with longer dwell times is 1050 °C

²External dimensions vary when furnace is equipped with additional equipment. Dimensions on request.

³Heating time of the empty and closed furnace up to Tmax -100 K (connected to 230 V 1/N/PE)

⁴Temperature uniformity of +/- 5 K with closed fresh-air inlet in empty work space according to DIN 17052-1 at working temperatures above 800 °C see page 71

*Please see page 75 for more information about supply voltage



Muffle furnace LE 1/11



Muffle furnace LE 14/11



Heating elements protected in quartz glass tubes

Muffle Furnaces with Brick Insulation up to 1300 °C

Heating elements on support tubes radiating freely into the furnace chamber provide for particularly short heating times for these muffle furnaces. Thanks to their robust lightweight refractory brick insulation, they can reach a maximum working temperature of 1300 °C. These muffle furnaces thus represent an interesting alternative to the familiar L(T) ../12 models, when you need a higher application temperature.



Muffle furnace L 9/13 with flap door

Standard Equipment

- Tmax 1300 °C
- Heating from two sides
- Heating elements on support tubes ensure free heat radiation and a long service life
- Multi-layer insulation with robust lightweight refractory bricks in the furnace chamber
- Optional flap door (L) which can be used as work platform or lift door (LT) with hot surface facing away from the operator
- Adjustable air inlet in the furnace door
- Exhaust air outlet in rear wall of furnace
- Controller B510 (5 programs with each 4 segments), alternative controllers see page 78

Additional Equipment

- Chimney, chimney with fan or catalytic converter see page 24
- Over-temperature limiter with adjustable cutout temperature as temperature limiter to protect the oven and load
- Protective gas connection to purge with non-flammable protective or reaction gases (not available in combination with chimney, chimney with fan or catalytic converter) not gas tight
- Manual or automatic gas supply system
- Port for thermocouple in the rear wall or in the furnace door
- Please see page 25 for more accessories

| Model | Tmax in °C ¹ | Inner dimensions in mm | | | Volume in l | Outer dimensions ² in mm | | | Temperature uniformity of +/- 5K in the empty workspace ⁵ | | | Connected load in kW | Electrical connection* | Weight in kg | Heating time in min ⁴ |
|-------------|----------------------------|------------------------|-----|-----|----------------|-------------------------------------|-----|----------------|--|-----|-----|----------------------------|---------------------------|-----------------|--|
| | | w | d | h | | W | D | H ³ | w | d | h | | | | |
| L, LT 5/13 | 1300 | 200 | 170 | 130 | 5 | 490 | 450 | 580+320 | 170 | 100 | 80 | 2.4 | 1-phase | 42 | 60 |
| L, LT 9/13 | 1300 | 230 | 240 | 170 | 9 | 530 | 525 | 630+350 | 180 | 170 | 120 | 3.0 | 1-phase | 60 | 60 |
| L, LT 15/13 | 1300 | 230 | 340 | 170 | 15 | 530 | 625 | 630+350 | 180 | 270 | 120 | 3.2 | 1-phase | 70 | 70 |

¹Recommended working temperature for processes with longer dwell times is 1200 °C

²External dimensions vary when furnace is equipped with additional equipment. Dimensions on request.

³Including opened lift door (LT models)

⁴Heating time of the empty and closed furnace up to Tmax -100 K (connected to 230 V 1/N/PE)

⁵Temperature uniformity of +/- 5 K with closed fresh-air inlet in empty work space according to DIN 17052-1 at working temperatures above 800 °C see page 71

*Please see page 75 for more information about supply voltage



Muffle furnace LT 5/13 with lift door



Furnace lining with high-quality lightweight refractory brick insulation



Example of an over-temperature limiter

Muffle Furnaces up to 1400 °C

These models stand out for their excellent workmanship, advanced and attractive design, and high level of reliability. Heating elements on support tubes radiating freely into the furnace chamber provide for particularly short heating times and a maximum temperature of 1400 °C. These muffle furnaces are a good alternative to the familiar L(T) ../12 series when higher application temperatures are needed.



Muffle furnace LT 9/14 with lift door

Standard Equipment

- Tmax 1400 °C
- Heating from two sides
- Heating elements on support tubes ensure free heat radiation and a long service life
- Adjustable air inlet integrated in door
- Exhaust air outlet in rear wall of furnace
- Controller B510 (5 programs with each 4 segments), alternative controllers see page 78

Additional Equipment

- Chimney, chimney with fan or catalytic converter see page 24
- Over-temperature limiter with adjustable cutout temperature as temperature limiter to protect the oven and load
- Protective gas connection to purge with non-flammable protective or reaction gases (not available in combination with chimney, chimney with fan or catalytic converter), not gas tight
- Manual or automatic gas supply system
- Please see page 25 for more accessories

| Model | Tmax in °C ¹ | Inner dimensions in mm | | | Volume in l | Outer dimensions ² in mm | | | Temperature uniformity of +/- 5K in the empty workspace ⁵ | | | Connected load in kW | Electrical connection* | Weight in kg | Heating time in min ⁴ |
|-------------|----------------------------|------------------------|-----|-----|----------------|-------------------------------------|-----|----------------|--|-----|-----|----------------------------|---------------------------|-----------------|-------------------------------------|
| | | w | d | h | | W | D | H ³ | w | d | h | | | | |
| L, LT 5/14 | 1400 | 200 | 170 | 130 | 5 | 490 | 450 | 580+320 | 170 | 120 | 80 | 2.4 | 1-phase | 42 | 50 |
| L, LT 9/14 | 1400 | 250 | 250 | 170 | 9 | 530 | 525 | 630+350 | 180 | 190 | 120 | 3.2 | 1-phase | 55 | 50 |
| L, LT 15/14 | 1400 | 250 | 350 | 170 | 15 | 530 | 625 | 630+350 | 180 | 290 | 120 | 3.2 | 1-phase | 63 | 70 |

¹Recommended working temperature for processes with longer dwell times is 1300 °C

²External dimensions vary when furnace is equipped with additional equipment. Dimensions on request.

³Including opened lift door

⁴Heating time of the empty and closed furnace up to Tmax -100 K (connected to 230 V 1/N/PE)

⁵Temperature uniformity of +/- 5 K with closed fresh-air inlet in empty work space according to DIN 17052-1 at working temperatures above 800 °C see page 71

*Please see page 75 for more information about supply voltage



Muffle furnace L 9/14 with flap door



Chimney with fan



Example of an over-temperature limiter

Muffle Furnaces with Embedded Heating Elements in the Ceramic Muffle up to 1100 °C

We particularly recommend the muffle furnace L 9/11/SKM for heat treatment of aggressive substances. The furnace has a ceramic muffle with embedded heating from four sides. The muffle furnace thus combines a very good temperature uniformity with excellent protection of the heating elements from aggressive atmospheres. Another aspect is the smooth, nearly particle free muffle (furnace door made of fiber insulation), an important quality feature.



Muffle furnace L 9/11/SKM with flap door

Standard Equipment

- Tmax 1100 °C
- Muffle heated from four sides
- Furnace chamber with embedded ceramic muffle, high resistance to aggressive gasses and vapours
- Optional flap door (L) which can be used as work platform or lift door (LT) with hot surface facing away from the operator
- Adjustable working air inlet in the door
- Exhaust air outlet in rear wall of furnace
- Controller B510 (5 programs with each 4 segments), alternative controllers see page 78

Additional Equipment

- Chimney, chimney with fan or catalytic converter see page 24
- Over-temperature limiter with adjustable cutout temperature as temperature limiter to protect the oven and load
- Protective gas connection to purge with non-flammable protective or reaction gases (not available in combination with chimney, chimney with fan or catalytic converter) not gas tight
- Manual or automation gas supply system
- Port for thermocouple in the rear wall or in the furnace door
- Please see page 25 for more accessories

| Modell | Tmax in °C ¹ | Inner dimensions in mm | | | Volume in l | Outer dimensions ² in mm | | | Connected load in kW | Electrical connection* | Weight in kg | Heating time in min ⁴ |
|-------------|----------------------------|------------------------|-----|-----|----------------|-------------------------------------|-----|----------------------|-------------------------|---------------------------|-----------------|-------------------------------------|
| | | w | d | h | | W | D | H | | | | |
| L 9/11/SKM | 1100 | 230 | 240 | 170 | 9 | 490 | 505 | 580 | 3.4 | 1-phase | 50 | 75 |
| LT 9/11/SKM | 1100 | 230 | 240 | 170 | 9 | 490 | 505 | 580+320 ³ | 3.4 | 1-phase | 50 | 75 |

¹Recommended working temperature for processes with longer dwell times is 1000 °C

²External dimensions vary when furnace is equipped with additional equipment. Dimensions on request.

³Including opened lift door

⁴Heating time of the empty and closed furnace up to Tmax – 100 K (connected to 230 V 1/N/PE)

*Please see page 75 for more information about supply voltage



Muffle furnace L 9/11/SKM



Gas supply system for non-flammable protective or reactive gas



Muffle heated from four sides

Ashing Furnaces up to 1100 °C

Ashing furnace LV .. /11 is designed especially for ashing processes to 1050 °C in the laboratory. Applications include determining loss on ignition, ashing food and plastics for subsequent substance analysis. A special fresh-air and exhaust air system ensures that the air is replaced 6 times per minute so that there is always sufficient oxygen for the ashing process. Incoming air passes the furnace heating and is pre-heated to ensure good temperature uniformity.



Ashing furnace LV 3/11

Standard Equipment

- Tmax 1100 °C
- Heating from two sides
- Ceramic heating plates with integral heating element which is safeguarded, and easy to replace
- Air exchange of more than 6 times per minute
- Good temperature uniformity due to preheating of incoming air, temperature uniformity according to DIN 17052-1 to ± 10 °C in the defined empty work area (from 550 °C) see page 71
- Suitable for many standardized ashing processes according to ISO, ASTM, EN, and DIN
- Optional flap door (LV) which can be used as work platform or lift door (LVT) with hot surface facing away from the operator
- Controller B510 (5 programs with each 4 segments), alternative controllers see page 78



Ashing furnace LVT 5/11

Additional Equipment

- Over-temperature limiter with adjustable cutout temperature as temperature limiter to protect the oven and load
- Port for thermocouple in the rear wall or in the furnace door
- Charging rack with closed or perforated trays for loading the furnace in two levels incl. holder for inserting/removing the trays up to a max. temperature of 800°C and a max. loading weight of 2 kg for the LV(T) 9/11 respectively 3 kg for the LV(T) 15/11
- Please see page 25 for more accessories

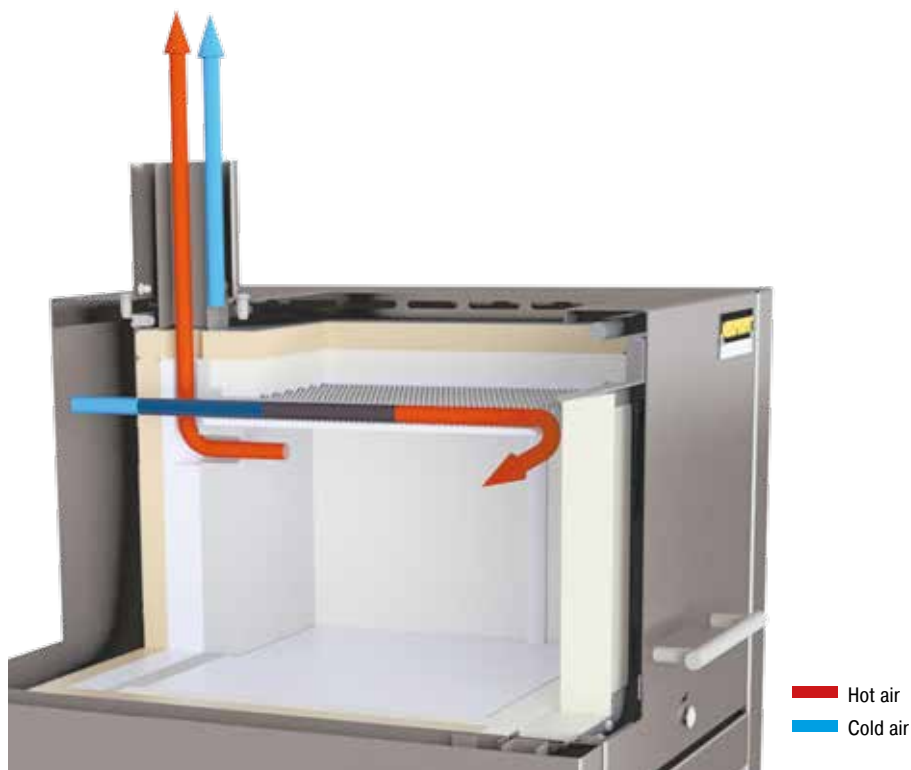

Air inlet and exhaust flow principle in ashing furnaces

| Model | Tmax in °C ¹ | Inner dimensions in mm | | | Volume in l | Outer dimensions ² in mm | | | Max. weight of hydrocarbons in g | Max. evapora- tion rate g/min | Connected load in kW | Electrical connection* | Weight in kg | Heating time in min ⁴ |
|-----------|----------------------------|------------------------|-----|-----|----------------|-------------------------------------|-----|----------------|--|-------------------------------------|----------------------------|---------------------------|-----------------|--|
| | | w | d | h | | W | D | H ³ | | | | | | |
| Flap door | | | | | | | | | | | | | | |
| LV 3/11 | 1100 | 160 | 140 | 100 | 3 | 385 | 360 | 735 | 5 | 0.1 | 1.2 | 1-phase | 20 | 45 |
| LV 5/11 | 1100 | 200 | 170 | 130 | 5 | 385 | 420 | 790 | 10 | 0.2 | 2.4 | 1-phase | 35 | 55 |
| LV 9/11 | 1100 | 230 | 240 | 170 | 9 | 415 | 485 | 845 | 15 | 0.3 | 3.0 | 1-phase | 45 | 70 |
| LV 15/11 | 1100 | 230 | 340 | 170 | 15 | 415 | 585 | 845 | 25 | 0.3 | 3.5 | 1-phase | 55 | 80 |

| Model | Tmax in °C ¹ | Inner dimensions in mm | | | Volume in l | Outer dimensions ² in mm | | | Max. weight of hydrocarbons in g | Max. evapora- tion rate g/min | Connected load in kW | Electrical connection* | Weight in kg | Heating time in min ⁴ |
|-----------|----------------------------|------------------------|-----|-----|----------------|-------------------------------------|-----|----------------|--|-------------------------------------|----------------------------|---------------------------|-----------------|--|
| | | w | d | h | | W | D | H ³ | | | | | | |
| Lift door | | | | | | | | | | | | | | |
| LVT 3/11 | 1100 | 160 | 140 | 100 | 3 | 385 | 360 | 735 | 5 | 0.1 | 1.2 | 1-phase | 20 | 45 |
| LVT 5/11 | 1100 | 200 | 170 | 130 | 5 | 385 | 420 | 790 | 10 | 0.2 | 2.4 | 1-phase | 35 | 55 |
| LVT 9/11 | 1100 | 230 | 240 | 170 | 9 | 415 | 485 | 845 | 15 | 0.3 | 3.0 | 1-phase | 45 | 70 |
| LVT 15/11 | 1100 | 230 | 340 | 170 | 15 | 415 | 585 | 845 | 25 | 0.3 | 3.5 | 1-phase | 55 | 80 |

¹Recommended working temperature for processes with longer dwell times is 1000 °C

²External dimensions vary when furnace is equipped with additional equipment. Dimensions on request.

³Including exhaust tube (Ø 80 mm)

⁴Approx. heating time of the empty and closed furnace up to Tmax - 100 K (connected to 230 V 1 N/PE)

*Please see page 75 for more information about supply voltage

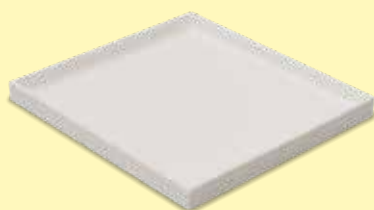

Ceramic collecting pan



Ashing furnace LV 5/11 with port for thermocouple in the rear wall of furnace



Charging trolley to load the furnace in different levels (for further information see page 20)

Ashing Furnaces with Integrated Exhaust Gas Cleaning up to 1100 °C

The ashing furnace L .. /11 BO is specially designed for processes in which larger sample quantities have to be incinerated. Fields of application are e.g. the ashing of food, thermal cleaning of injection molding tools or the determination of annealing loss. Another application is the debinding of ceramic products, e.g. after additive production.

The ashing furnaces have a passive safety system and integrated exhaust gas post combustion. An exhaust gas fan extracts flue gases from the furnace and simultaneously supplies fresh air to the furnace atmosphere with the result that sufficient oxygen is always available for the incineration process. The incoming air is guided behind the furnace heating and preheated to ensure good temperature uniformity. Exhaust gases are led from the furnace chamber to the integrated post combustion system, where they are postburned and catalytically cleaned. Directly after the incineration process (up to max. 600 °C) a subsequent process up to max. 1100 °C can take place.

Standard Equipment

- Tmax 600 °C for the incineration process
- Tmax 1100 °C for the subsequent process
- Three-side heating (both sides and bottom)
- Ceramic heating plates with embedded heating wire
- Steel collecting pan protects the bottom insulation
- Spring-assisted closing of the furnace door (flap door) with mechanical locking against unintentional opening
- Thermal/catalytic post combustion, integrated in the exhaust channel, up to 600 °C in function
- Temperature control of post combustion can be set up to 850 °C
- Monitored exhaust air
- Inlet-air preheated through the bottom heating plate
- Over-temperature limiter with adjustable cutout temperature as temperature limiter to protect the oven and load
- Controller C550 (10 programs with each 20 segments), alternative controllers see page 78



Ashing furnace L 40/11 BO

| Model | Tmax in °C ¹ | Inner dimensions in mm | | | Volume in l | Outer dimensions ² in mm | | | Max. weight of hydrocarbons in g | Max. evaporation rate g/min | Connected load in kW | Electrical connection* | Weight in kg |
|------------|----------------------------|------------------------|-----|-----|----------------|-------------------------------------|-----|----------------|--|-----------------------------------|-------------------------|---------------------------|-----------------|
| | | w | d | h | | W | D | H ³ | | | | | |
| L 9/11 BO | 1100 | 230 | 240 | 170 | 9 | 415 | 575 | 750 | 75 | 1.0 | 7.0 | 3-phase | 60 |
| L 24/11 BO | 1100 | 280 | 340 | 250 | 24 | 490 | 675 | 800 | 150 | 2.0 | 9.0 | 3-phase | 90 |
| L 40/11 BO | 1100 | 320 | 490 | 250 | 40 | 530 | 825 | 800 | 200 | 2.1 | 11.5 | 3-phase | 110 |

¹Recommended working temperature for processes with longer dwell times is 1000 °C

²External dimensions vary when furnace is equipped with additional equipment. Dimensions on request.

³Including exhaust tube (Ø 80 mm)

*Please see page 75 for more information about supply voltage



Ashing furnace L 9/11 BO



Schematic presentation of air circulation in ashing furnace L 24/11 BO



Steel collecting pan protects the bottom insulation

Muffle Furnace incl. Scale and Software for Determination of Combustion Loss

This weighing furnace with integrated precision scale and software, was designed especially for combustion loss determination in the laboratory. The determination of combustion loss is necessary, for instance, when analyzing sludges and household garbage, and is also used in a variety of other processes for the evaluation of results. The difference between the charged total mass and the combustion residue is the combustion loss. During the process, the software included records both the temperature and the weight loss.



Weighing furnace L 9/11/SW with flap door

Standard Equipment

- Like muffle furnaces L(T), except:
- Delivery includes base, ceramic plunger with base plate in the furnace lining, precision scale and software package
 - 4 scales available for different maximum weights and scaling ranges
 - Process control and documentation for temperature and combustion loss via VCD software package for monitoring, documentation and control see page 80
 - Controller B510 (5 programs with each 4 segments), alternative controllers see page 78

Additional Equipment

- Chimney, chimney with fan or catalytic converter
- Over-temperature limiter with adjustable cutout temperature as temperature limiter to protect the oven and load
- Port for thermocouple in the rear wall or in the furnace door
- Please see page 24 for more accessories

| Model | Tmax in °C ¹ | Inner dimensions in mm | | | Volume in l | Outer dimensions ² in mm | | | Connected load in kW | Electrical connection* | Weight in kg | Heating time in min ⁴ |
|--------------|----------------------------|------------------------|-----|-----|----------------|-------------------------------------|-----|----------------------|-------------------------|---------------------------|-----------------|-------------------------------------|
| | | w | d | h | | W | D | H | | | | |
| L(T) 9/11/SW | 1100 | 230 | 240 | 170 | 9 | 415 | 455 | 740+240 ³ | 3.0 | 1-phase | 50 | 65 |
| L(T) 9/12/SW | 1200 | 230 | 240 | 170 | 9 | 415 | 455 | 740+240 ³ | 3.0 | 1-phase | 50 | 75 |

¹Recommended working temperature for processes with longer dwell times is 1000 °C (L 9/11) resp. 1100 °C (L 9/12)
²External dimensions vary when furnace is equipped with additional equipment. Dimensions on request.
³Including opened lift door (Model LT ..)
⁴Heating time of the empty and closed furnace up to Tmax –100 K (connected to 230 V 1/N/PE)

*Please see page 75 for more information about supply voltage

| Scale type | Readability in g | Maximum weighing range in g | Weight of plunger in g | Calibration value in g | Minimum load in g |
|------------|---------------------|--------------------------------|---------------------------|---------------------------|----------------------|
| EW-2200 | 0.01 | 2200 incl. plunger | 850 | 0.1 | 0.5 |
| EW-4200 | 0.01 | 4200 incl. plunger | 850 | 0.1 | 0.5 |
| EW-6200 | 0.01 | 6200 incl. plunger | 850 | - | 1.0 |
| EW-12000 | 0.10 | 12000 incl. plunger | 850 | 1.0 | 5.0 |



4 scales available for different maximum weights and scaling ranges



Example of an over-temperature limiter



Software for documentation of the temperature curve and combustion loss using a PC

Exhaust Systems/Accessories



Article No.: 631000140



Article No.: 631000812



Article No.: 631000166

Exhaust Vent

Exhaust vent for collection and upstream direction of escaping gases

Chimney with Fan

Exhaust gases are better removed from the furnace and discharged. The B500 - P580 controllers can be used to activate the fan automatically (not for models L 1/12, LE 1/11, LE 2/11).*

Catalytic Converter with Fan

Organic components are catalytically cleaned at about 600 °C, broken into carbon dioxide and water vapour. Irritating odors are thus largely eliminated. The B500 - P580 controllers can be used to switch the catalytic converter automatically (not for models L(T) 9/14, L(T) 15..., L 1/12, LE 1/11, LE 2/11).*

* Note: If other controller types are used an adapter cable for connection to mains supply has to be ordered separately. The device will be activated by plugging in the socket.

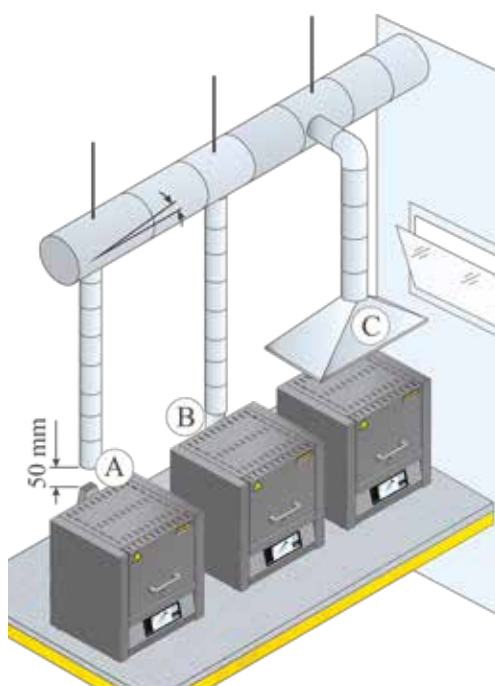

Various ways of removing the exhaust air

Exhaust Air Extraction

When exhaust gases are generated during the process it is mandatory to guide them outside in an adequate way. The relevant operating instructions must be always taken into consideration. When exhaust gas pipings are installed it is always necessary that a local ventilation technician lays out the system in accordance to the real environment.

There are different possibilities to guide the exhaust gases out. In many cases the furnace is positioned under a laboratory extraction provided by the customer. In these cases the use of an exhaust vent is recommended just to guide the gases upwards.

For this purpose metal exhaust gas pipes with NW 80 to NW 120 can be used. They must be installed continuously rising and fastened to the wall or ceiling. Center the pipe over the furnace vent (for models with vent fan or catalytic converter, NW 120 is necessary. The exhaust gas pipe must not be installed with a tight fit to the furnace vent pipe since this would prevent any bypass effect. This is necessary so that not too much fresh air is sucked in by the furnace. An exception are models LV(T) and L ../11 BOs: Here the exhaust gas pipe NW 80 will be connected directly onto the furnace vent pipe.



Article No.:
699000279: sagger
110 x 75 x 30 mm
699000985: lid
110 x 75 x 5 mm



Article No.:
699001054: sintering dish
Ø 115 x 15 mm
699001055: spacer ring
Ø 115 x 20 mm

Square Sagger for Furnaces LHTC and LHT, Tmax 1600 °C

The load is placed in ceramic saggars for optimal utilization of the furnace space. Up to three saggars can be stacked on top of each other in the furnace. In models LHT 01/17 D and LHTCT 01/16 up to two saggars can be stacked. Each sagger has cut-outs for better ventilation. The top sagger should be closed with a lid made of ceramic.

Round Sagger (Ø 115 mm) for Furnaces LHT/LB, Tmax 1650 °C

These saggars are perfectly suited for furnaces LHT/LB. The load is placed in the saggars. Up to three saggars can be stacked on top of each other in order to use the overall furnace chamber.

Select between different bottom plates and collecting pans for protection of the furnace and easy loading (for models L, LT, LE, LV and LVT on pages 14 - 23). Steel collecting pans may deform/distort under heat. For batches that are sensitive to tipping, ceramic shelves to protect the furnace bottom are recommended..



Ceramic Ribbed Plate, Tmax 1200 °C



Ceramic Collecting Pan, Tmax 1300 °C



Stainless Steel Collecting Pan, Tmax 1100 °C

| For models | Ceramic ribbed plate | | Ceramic collecting pan | | Stainless steel collecting pan (Material 1.4828) | |
|----------------------------------|----------------------|------------------|------------------------|------------------|--|------------------|
| | Articel No. | Dimensions in mm | Articel No. | Dimensions in mm | Articel No. | Dimensions in mm |
| L 1, LE 1 | 691601835 | 110 x 90 x 12.7 | - | - | 691404623 | 85 x 100 x 20 |
| LE 2 | 691601097 | 170 x 110 x 12.7 | 691601099 | 100 x 160 x 10 | 691402096 | 110 x 170 x 20 |
| L 3, LT 3, LV 3, LVT 3 | 691600507 | 150 x 140 x 12.7 | 691600510 | 150 x 140 x 20 | 691400145 | 150 x 140 x 20 |
| LE 6, L 5, LT 5, LV 5, LVT 5 | 691600508 | 190 x 170 x 12.7 | 691600511 | 190 x 170 x 20 | 691400146 | 190 x 170 x 20 |
| L 9, LT 9, LV 9, LVT 9, N 7 | 691600509 | 240 x 220 x 12.7 | 691600512 | 240 x 220 x 20 | 691400147 | 240 x 220 x 20 |
| LE 14 | 691601098 | 210 x 290 x 12.7 | - | - | 691402097 | 210 x 290 x 20 |
| L 15, LT 15, LV 15, LVT 15, N 11 | 691600506 | 340 x 220 x 12.7 | - | - | 691400149 | 230 x 330 x 20 |
| L 24, LT 24 | 691600874 | 340 x 270 x 12.7 | - | - | 691400626 | 270 x 340 x 20 |
| L 40, LT 40 | 691600875 | 490 x 310 x 12.7 | - | - | 691400627 | 310 x 490 x 20 |



Article No.:
493000004

Gloves, Tmax 650 °C

For protection of the operator when loading or removing hot materials



Article No.:
491041101

Gloves, Tmax 700 °C

For protection of the operator when loading or removing hot materials



Article No.:
493000002 (300 mm)
493000003 (500 mm)

Charing Tongs

For easy loading and unloading of the furnace

Chamber Furnaces up to 1400 °C

Furnaces with sturdy insulation made from lightweight refractory bricks for rough use in the laboratory.



Dual shell housing made of textured stainless steel sheets with additional fan cooling for low surface temperature



Solid state relays provide for lownoise operation



Exclusive use of insulation materials without categorization according to EC Regulation No 1272/2008 (CLP). This explicitly means that alumino silicate wool, also known as “refractory ceramic fiber” (RCF), which is classified and possibly carcinogenic, is not used.



NTLog Basic for Nabertherm controller: recording of process data with USB-flash drive



Defined application within the constraints of the operating instructions



As additional equipment: Process control and documentation via VCD software package for monitoring, documentation and control



| Furnace Group | Model | Page |
|--|--------|------|
| Chamber furnaces up to 1400 °C | LH, LF | 28 |
| Chamber furnaces up to 1280 °C | N ../H | 30 |
| Accessories for the heat treatment of metals | | 31 |

Chamber Furnaces with Brick Insulation or Fiber Insulation up to 1400 °C

These big chamber furnaces LH 15/12 - LF 120/14 have been trusted for many years as professional chamber furnaces for the laboratory. These furnaces are available with either a robust insulation of light refractory bricks (LH models) or with a combination insulation of refractory bricks in the corners and low heat storage, quickly cooling fiber material (LF models). With a wide variety of optional equipment, these chamber furnaces can be optimally adapted to your processes.



Chamber furnace LH 30/14

Standard Equipment

- Tmax 1200 °C, 1300 °C, or 1400 °C
- High furnace chamber with five-sided heating for very good temperature uniformity
- Heating elements on support tubes ensure free heat radiation and a long service life
- Controller mounted on furnace door and removable for comfortable operation
- Protection of bottom heating and flat stacking surface provided by embedded SiC plate in the floor
- LH models: multi-layered insulation of light refractory bricks and special backup insulation
- LF models: high-quality fiber insulation with corner bricks for shorter heating and cooling times
- Door with brick-on-brick seal, hand fitted
- Generously dimensioned heating provides for short heating times
- Self-supporting arch for high stability and greatest possible protection against dust
- Motorized exhaust air flaps
- Freely adjustable air inlet integrated in furnace floor
- Base included
- Controller B500 (5 programs with each 4 segments), alternative controllers see page 78



Chamber furnace LH 216/12 with fresh air fan to accelerate the cooling times

Additional Equipment

- Parallel swinging door for opening when hot with hot surface facing away from the operator
- Lift door with electro-mechanic linear drive
- Separate wall-mounting or floor standing cabinet for switchgear
- Cooling system to cool the furnace with a defined temperature gradient or with a preset fresh air volume. Both operating modes can be switched on and off for different segments by means of the extra function of the controller.
- Protective gas connection to purge with non-flammable protective or reaction gases
- Manual or automatic gas supply system
- Scale to measure weight reduction during annealing



Chamber furnace LH 30/12 with manual lift door



Chamber furnace LH 60/12 SW with scale to measure weight reduction during annealing

| Model | Tmax in °C | Inner dimensions in mm | | | Volume in l | Outer dimensions ¹ in mm | | | Connected load in kW | Electrical connection* | Weight in kg |
|-----------|---------------|------------------------|-----|-----|----------------|-------------------------------------|------|------|-------------------------|---------------------------|-----------------|
| | | w | d | h | | W | D | H | | | |
| LH 15/12 | 1200 | 250 | 250 | 250 | 15 | 680 | 860 | 1230 | 5.0 | 3-phase ² | 170 |
| LH 30/12 | 1200 | 320 | 320 | 320 | 30 | 710 | 930 | 1290 | 7.0 | 3-phase ² | 200 |
| LH 60/12 | 1200 | 400 | 400 | 400 | 60 | 790 | 1080 | 1370 | 8.0 | 3-phase | 300 |
| LH 120/12 | 1200 | 500 | 500 | 500 | 120 | 890 | 1180 | 1470 | 12.0 | 3-phase | 410 |
| LH 216/12 | 1200 | 600 | 600 | 600 | 216 | 990 | 1280 | 1590 | 20.0 | 3-phase | 450 |
| LH 15/13 | 1300 | 250 | 250 | 250 | 15 | 680 | 860 | 1230 | 7.0 | 3-phase ² | 170 |
| LH 30/13 | 1300 | 320 | 320 | 320 | 30 | 710 | 930 | 1290 | 8.0 | 3-phase ² | 200 |
| LH 60/13 | 1300 | 400 | 400 | 400 | 60 | 790 | 1080 | 1370 | 11.0 | 3-phase | 300 |
| LH 120/13 | 1300 | 500 | 500 | 500 | 120 | 890 | 1180 | 1470 | 15.0 | 3-phase | 410 |
| LH 216/13 | 1300 | 600 | 600 | 600 | 216 | 990 | 1280 | 1590 | 22.0 | 3-phase | 460 |
| LH 15/14 | 1400 | 250 | 250 | 250 | 15 | 680 | 860 | 1230 | 8.0 | 3-phase ² | 170 |
| LH 30/14 | 1400 | 320 | 320 | 320 | 30 | 710 | 930 | 1290 | 10.0 | 3-phase ² | 200 |
| LH 60/14 | 1400 | 400 | 400 | 400 | 60 | 790 | 1080 | 1370 | 12.0 | 3-phase | 300 |
| LH 120/14 | 1400 | 500 | 500 | 500 | 120 | 890 | 1180 | 1470 | 18.0 | 3-phase | 410 |
| LH 216/14 | 1400 | 600 | 600 | 600 | 216 | 990 | 1280 | 1590 | 26.0 | 3-phase | 470 |
| LF 15/13 | 1300 | 250 | 250 | 250 | 15 | 680 | 860 | 1230 | 7.0 | 3-phase ² | 150 |
| LF 30/13 | 1300 | 320 | 320 | 320 | 30 | 710 | 930 | 1290 | 8.0 | 3-phase ² | 180 |
| LF 60/13 | 1300 | 400 | 400 | 400 | 60 | 790 | 1080 | 1370 | 11.0 | 3-phase | 270 |
| LF 120/13 | 1300 | 500 | 500 | 500 | 120 | 890 | 1180 | 1470 | 15.0 | 3-phase | 370 |
| LF 15/14 | 1400 | 250 | 250 | 250 | 15 | 680 | 860 | 1230 | 8.0 | 3-phase ² | 150 |
| LF 30/14 | 1400 | 320 | 320 | 320 | 30 | 710 | 930 | 1290 | 10.0 | 3-phase ² | 180 |
| LF 60/14 | 1400 | 400 | 400 | 400 | 60 | 790 | 1080 | 1370 | 12.0 | 3-phase | 270 |
| LF 120/14 | 1400 | 500 | 500 | 500 | 120 | 890 | 1180 | 1470 | 18.0 | 3-phase | 370 |

¹External dimensions vary when furnace is equipped with additional equipment. Dimensions on request.

²Heating only between two phases

*Please see page 75 for more information about supply voltage



Parallel swinging door for opening when hot



Gas panel for one non-flammable protective or reactive gas (N₂, Ar, He, CO₂, air, forming gas)



LF furnace design provides for shorter heating and cooling times

Chamber Furnaces for Annealing, Hardening and Brazing up to 1280 °C

To withstand harsh use in the laboratory, e.g. when heat-treating metals, robust insulation with light refractory bricks is necessary. The chamber furnaces N 7/H - N 87/H are a perfect fit to solve this problem. The furnaces can be extended with a variety of accessories, like annealing boxes for operation under protective gas, roller guides, or a cooling station with a quench tank. Even high-performance applications like the annealing of titanium in medical applications can be implemented without the use of expensive and complicated annealing systems.



Chamber furnace N 61/H

Standard Equipment

- Tmax 1280 °C
- Deep furnace chamber with three-sides heating: from both side walls and bottom
- Heating elements on support tubes ensure free heat radiation and a long service life
- Bottom heating protected by heat-resistant SiC plate
- Temperature uniformity up to +/- 10 °C according to DIN 17052-1 see page 71
- Low energy consumption due to multi-layer insulation
- Base frame included in the delivery, N 7/H - N 17/HR designed as table-top model
- Parallel guided downward swinging door (user protected from heat radiation)
- Door movement cushioned with gas dampers/struts
- Controller B500 (5 programs with each 4 segments), alternative controllers see page 78

| Model | Tmax in °C | Inner dimensions in mm | | | Volume in l | Outer dimensions ¹ in mm | | | Connected load in kW | Electrical connection* | Weight in kg | Heating time in min ² |
|---------|---------------|------------------------|------|-----|----------------|-------------------------------------|------|------|-------------------------|---------------------------|-----------------|-------------------------------------|
| | | w | d | h | | W | D | H | | | | |
| N 7/H | 1280 | 250 | 250 | 140 | 9 | 800 | 650 | 600 | 3.0 | 1-phase | 60 | 320 |
| N 11/H | 1280 | 250 | 350 | 140 | 11 | 800 | 750 | 600 | 3.5 | 1-phase | 70 | 320 |
| N 11/HR | 1280 | 250 | 350 | 140 | 11 | 800 | 750 | 600 | 5.5 | 3-phase ³ | 70 | 70 |
| N 17/HR | 1280 | 250 | 500 | 140 | 17 | 800 | 900 | 600 | 6.4 | 3-phase ³ | 90 | 110 |
| N 31/H | 1280 | 350 | 350 | 250 | 31 | 1040 | 1100 | 1340 | 15.0 | 3-phase | 210 | 90 |
| N 41/H | 1280 | 350 | 500 | 250 | 41 | 1040 | 1250 | 1340 | 15.0 | 3-phase | 260 | 105 |
| N 61/H | 1280 | 350 | 750 | 250 | 61 | 1040 | 1500 | 1340 | 20.0 | 3-phase | 400 | 105 |
| N 87/H | 1280 | 350 | 1000 | 250 | 87 | 1040 | 1750 | 1340 | 25.0 | 3-phase | 480 | 105 |

¹External dimensions vary when furnace is equipped with additional equipment. Dimensions on request.

²Heating time of the empty and closed furnace up to Tmax - 100 K (connected to 230 V 1/N/PE resp. 400 V 3/N/PE)

³Heating only between two phases

*Please see page 75 for more information about supply voltage



Working with protective gas boxes for a protective gas atmosphere using a charging cart



Chamber furnace N 7/H as table-top model



Deep furnace chamber with three-sides heating

Accessories for the Heat Treatment of Metals

Our wide range of furnaces for heat treatment of metals can be extended with a large selection of accessories to suit to the specific application.

Protective Gas Boxes for Heat Treatment in Protective Gas

By using protective gas boxes, annealing furnaces, forced convection furnaces and pit-type furnaces can be upgraded for heat treatment processes under non-flammable protective and reactive gases.



Annealing Boxes

Annealing boxes are filled with powder or granules into which the charge is placed. Processes like soldering can be carried out in an inexpensive manner.



Complete Workshop Hardening Systems

The Nabertherm compact hardening systems consist of a hardening furnace, a tempering furnace, a quenching and cleaning bath. They can be used for various heat treatment processes in the workshop.



Quenching and Cleaning Baths

Baths for quenching in oil or water as well as for cleaning and degreasing are available as single or double baths and are made of stainless steel.



Auxiliary Materials for Better Charge Results

Hardening foils, annealing bags, granulate



Protective Equipment

Gloves, face and body protection



For more information about our extensive range of heat treatment accessories, please request our catalog "Thermal Process Technology II"

High-Temperature Furnaces up to 1800 °C

High-temperature furnaces as table or stand models for maximum temperatures between 1400 °C and 1800 °C, for example for sintering ceramics or for melting small glass samples.



Dual shell housing made of textured stainless steel sheets with additional fan cooling for low surface temperature



Stainless steel exhaust hood as interface to customer's exhaust system for all standing models



Exclusive use of insulation materials without categorization according to EC Regulation No 1272/2008 (CLP). This explicitly means that alumino silicate wool, also known as "refractory ceramic fiber" (RCF), which is classified and possibly carcinogenic, is not used.



NTLog Basic for Nabertherm controller: recording of process data with USB-flash drive



Defined application within the constraints of the operating instructions



As additional equipment: Process control and documentation via VCD software package for monitoring, documentation and control



| Furnace Group | Model | Page |
|--|-----------|------|
| High-temperature furnaces with SiC rod heating Table-top model up to 1600 °C | LHTC(T) | 34 |
| High-temperature furnaces with MoSi ₂ heating elements Table-top model up to 1800 °C | LHT | 35 |
| High-temperature bottom loading furnaces up to 1700 °C | LHT ../LB | 36 |
| High-temperature furnaces with scale up to 1750 °C | LHT ../SW | 37 |
| High-temperature furnaces with MoSi ₂ heating elements Floor-standing model up to 1800 °C | HT | 38 |
| High-temperature furnaces with SiC rod heating Floor-standing model up to 1550 °C | HTC | 40 |
| High-temperature furnaces with MoSi ₂ heating elements Refractory brick insulation up to 1700 °C | HFL | 41 |

High-Temperature Furnaces with SiC Rod Heating up to 1600 °C

These powerful laboratory muffle furnaces are available for temperatures up to 1400 °C, 1500 °C, 1550 °C or 1600 °C. The durability of the SiC rods in periodic use, in combination with their high heating speed, make these high-temperature furnaces to all-rounders in the laboratory. Heating times of 20 - 25 minutes to 1400 °C can be achieved, depending on the furnace model and the conditions of use.



High-temperature furnace LHTCT 01/16

Standard Equipment

- Tmax 1400 °C, 1500 °C, 1550 °C or 1600 °C
- Working temperature 1500 °C (for high-temperature furnaces LHTC ../16), increased wear and tear must be expected in case of working at higher temperatures
- Optional flap door (LHTC) which can be used as work platform or lift door (LHTCT) with hot surface facing away from the operator (High-temperature furnace LHTCT 01/16 only with lift door)
- Switching system with solid-state-relays, power tuned to the SiC rods
- Easy replacement of heating rods
- Adjustable air inlet opening, exhaust air opening in the roof
- Controller C550 (10 programs with each 20 segments), alternative controllers see page 78

Additional Equipment

- Over-temperature limiter with adjustable cutout temperature as temperature limiter to protect the oven and load
- Protective gas connection to purge with non-flammable protective or reaction gases, not gas tight
- Manual or automatic gas supply system

| Model | Tmax in °C | Inner dimensions in mm | | | Volume in l | Outer dimensions ¹ in mm | | | Connected load in kW | Electrical connection* | Weight in kg | Heating time in min ³ |
|---------------|---------------|------------------------|-----|-----|----------------|-------------------------------------|-----|----------------|-------------------------|---------------------------|-----------------|-------------------------------------|
| | | w | d | h | | W | D | H ² | | | | |
| LHTC(T) 03/14 | 1400 | 120 | 210 | 120 | 3.0 | 415 | 545 | 490 | 10.0 | 3-phase ⁴ | 30 | 20 |
| LHTC(T) 08/14 | 1400 | 170 | 290 | 170 | 8.0 | 490 | 625 | 540 | 15.5 | 3-phase | 40 | 20 |
| LHTC(T) 03/15 | 1500 | 120 | 210 | 120 | 3.0 | 415 | 545 | 490 | 10.0 | 3-phase ⁴ | 30 | 25 |
| LHTC(T) 08/15 | 1500 | 170 | 290 | 170 | 8.0 | 490 | 625 | 540 | 15.5 | 3-phase | 40 | 20 |
| LHTCT 01/16 | 1550 | 110 | 120 | 120 | 1.5 | 340 | 300 | 460 | 3.5 | 1-phase | 18 | 30 |
| LHTC(T) 03/16 | 1600 | 120 | 210 | 120 | 3.0 | 415 | 545 | 490 | 10.0 | 3-phase ⁴ | 30 | 30 |
| LHTC(T) 08/16 | 1600 | 170 | 290 | 170 | 8.0 | 490 | 625 | 540 | 15.5 | 3-phase | 40 | 25 |

¹External dimensions vary when furnace is equipped with additional equipment. Dimensions on request.

²Plus maximum 240 mm for models LHTCT when open

³Heating time of the empty and closed furnace up to Tmax - 100 K (connected to 230 V 1/N/PE resp. 400 V 3/N/PE)

*Please see page 75 for more information about supply voltage

⁴Heating only between two phases



High-temperature furnace LHTC 08/16



Gas supply system for non-flammable protective or reactive gas



Furnace chamber with high-quality fiber materials and SiC heating rods on both sides of the furnace

High-Temperature Furnaces with MoSi₂ Heating Elements up to 1800 °C

Designed as tabletop models, these compact high-temperature furnaces have a variety of advantages. The first-class workmanship using high-quality materials, combined with ease of operation, make these furnaces all-rounders in research and the laboratory. These high-temperature furnaces are also perfectly suited for the sintering of technical ceramics, such as zirconium oxide dental bridges.



High-temperature furnace LHT 01/17 D

Standard Equipment

- Tmax 1600 °C, 1750 °C, or 1800 °C
- Recommended working temperature 1750 °C (for models LHT ../18), increased wear and tear must be expected in case of working at higher temperatures
- High-quality molybdenum disilicide heating elements
- Adjustable air inlet opening, exhaust air opening in the roof
- Type B thermocouple
- Controller P570 (50 programs with each 40 segments), controls description see page 78

Additional Equipment

- Over-temperature limiter with adjustable cutout temperature as temperature limiter to protect the oven and load
- Protective gas connection to purge with non-flammable protective or reaction gases, not gas tight
- Manual or automatic gas supply system

| Model | Tmax in °C | Inner dimensions in mm | | | Volume in l | Outer dimensions ¹ in mm | | | Connected load in kW | Electrical connection* | Weight in kg | Heating time in min ³ |
|-------------|------------|------------------------|-----|-----|-------------|-------------------------------------|-----|----------------|----------------------|------------------------|--------------|----------------------------------|
| | | w | d | h | | W | D | H ² | | | | |
| LHT 02/16 | 1600 | 90 | 150 | 150 | 2 | 470 | 630 | 760+260 | 3.0 | 1-phase | 75 | 30 |
| LHT 04/16 | 1600 | 150 | 150 | 150 | 4 | 470 | 630 | 760+260 | 5.2 | 3-phase ⁴ | 85 | 25 |
| LHT 08/16 | 1600 | 150 | 300 | 150 | 8 | 470 | 810 | 760+260 | 8.0 | 3-phase ⁴ | 100 | 25 |
| LHT 01/17 D | 1650 | 110 | 120 | 120 | 1 | 385 | 425 | 525+195 | 2.9 | 1-phase | 28 | 35 |
| LHT 03/17 D | 1650 | 135 | 155 | 200 | 4 | 470 | 630 | 760+260 | 3.0 | 1-phase | 75 | 30 |
| LHT 02/17 | 1750 | 90 | 150 | 150 | 2 | 470 | 630 | 760+260 | 3.0 | 1-phase | 75 | 35 |
| LHT 04/17 | 1750 | 150 | 150 | 150 | 4 | 470 | 630 | 760+260 | 5.2 | 3-phase ⁴ | 85 | 30 |
| LHT 08/17 | 1750 | 150 | 300 | 150 | 8 | 470 | 810 | 760+260 | 8.0 | 3-phase ⁴ | 100 | 30 |
| LHT 02/18 | 1800 | 90 | 150 | 150 | 2 | 470 | 630 | 760+260 | 3.6 | 1-phase | 75 | 60 |
| LHT 04/18 | 1800 | 150 | 150 | 150 | 4 | 470 | 630 | 760+260 | 5.2 | 3-phase ⁴ | 85 | 40 |
| LHT 08/18 | 1800 | 150 | 300 | 150 | 8 | 470 | 810 | 760+260 | 9.0 | 3-phase ⁴ | 100 | 40 |

¹External dimensions vary when furnace is equipped with additional equipment. Dimensions on request.

²Including opened lift door

³Heating time of the empty and closed furnace up to Tmax - 100 K (connected to 230 V 1/N/PE resp. 400 V 3/N/PE)

*Please see page 75 for more information about supply voltage

⁴Heating only between two phases



High-temperature furnace LHT 01/17 D



Saggars with top lid



Example of an over-temperature limiter

High-Temperature Bottom Loading Furnaces up to 1700 °C

The motor-driven lifting table significantly simplifies the charging of the high-temperature furnaces LHT ../. LB (Speed). The heating all around the cylindrical furnace chamber provides for an optimal temperature uniformity. For the tabletop models LHT 01/17 LB Speed and LHT 02/17 LB Speed the charge can be placed in charge saggars made of technical ceramics. Up to three charge saggars can be stacked on top of each other resulting in a high productivity.



High-temperature furnace LHT 02/17 LB Speed with a set of saggars

Standard Equipment

- Tmax 1650 °C, 1700 °C (LHT 16/17 LB)
- High-quality heating elements made of molybdenum disilicide offer very good protection against chemical interaction between charge and heating elements
- Excellent temperature uniformity thanks to three (LHT 02/17 LB Speed) or four-sided (LHT 01/17 LB Speed) heating of the furnace chamber
- Furnace chamber with a volume of 1, 2 or 16 liters, table with large floor space
- Precise, motorized toothed belt drive of the table with button operation
- Exhaust air vent in the roof
- Type S thermocouple
- Controller P580 (50 programs with each 40 segments), controls description see page 78

Additional Equipment

- Over-temperature limiter with adjustable cutout temperature as temperature limiter to protect the oven and load
- Stackable saggars for loading in up to two or three levels, depending on model, see page 25
- Adjustable air inlet through the floor

| Model | Tmax in °C | Work space dimensions ² in mm | | | Charging area in mm | | Volume in l | Outer dimensions ¹ in mm | | | Connected load in kW | Electrical connection* | Weight in kg |
|--------------------|---------------|--|-----|-----|---------------------|-----|----------------|-------------------------------------|-----|-----|-------------------------|---------------------------|-----------------|
| | | w | d | h | w | d | | W | D | H | | | |
| LHT 01/17 LB Speed | 1650 | 75 | 110 | 60 | 95 | 130 | 1 | 350 | 590 | 695 | 2.9 | 1-phase | 45 |
| LHT 02/17 LB Speed | 1650 | Ø 115 | | 110 | 135 | 135 | 2 | 390 | 590 | 785 | 3.3 | 1-phase | 55 |

¹External dimensions vary when furnace is equipped with additional equipment. Dimensions on request.

²Corresponds to charge saggars with spacer

*Please see page 75 for more information about supply voltage



Electrically driven lift-bottom



Saggars



Furnace chamber heated on four sides for model LHT 01/17 LB Speed

High-Temperature Furnaces with Scale for Determination of Combustion Loss and Thermogravimetric Analysis (TGA) up to 1750 °C

These high-temperature furnaces were specially developed to determine combustion loss during annealing and for thermogravimetric analysis (TGA) in the lab. The complete system consists of the high-temperature furnace for 1600 °C or 1750 °C, a table frame, precision scale with feedthroughs into the furnace and powerful software for recording both the temperature curve and the weight loss over time.



High-temperature furnace LHT 04/16 SW with scale for measuring weight reduction during annealing

Standard Equipment

- Tmax 1600 °C or 1750 °C
- High-quality molybdenum disilicide heating elements
- Dual shell housing made of textured stainless steel sheets with additional fan cooling for low surface temperature
- Adjustable air inlet
- Exhaust air opening in the roof
- Type B thermocouple
- Delivery includes base, ceramic plunger with base plate in the furnace lining, precision scale and software package
- 4 scales available for different maximum weights and scaling ranges
- Process control and documentation for temperature and combustion loss via VCD software package for monitoring, documentation and control see page 80

| Model | Tmax in °C | Inner dimensions in mm | | | Volume in l | Outer dimensions ¹ in mm | | | Connected load in kW | Electrical connection* | Weight in kg | Heating time in min ² |
|--------------|---------------|------------------------|-----|-----|----------------|-------------------------------------|-----|-----|-------------------------|---------------------------|-----------------|-------------------------------------|
| | | w | d | h | | W | D | H | | | | |
| LHT 04/16 SW | 1600 | 150 | 150 | 150 | 4 | 655 | 370 | 890 | 5.0 | 3-phase ³ | 85 | 25 |
| LHT 04/17 SW | 1750 | 150 | 150 | 150 | 4 | 655 | 370 | 890 | 5.0 | 3-phase ³ | 85 | 30 |

¹External dimensions vary when furnace is equipped with additional equipment. Dimensions on request.
²Heating time of the empty and closed furnace up to Tmax –100 K (connected to 230 V 1/N/PE resp. 400 V 3/N/PE)
³Heating only between two phases

*Please see page 75 for more information about supply voltage

| Scale type | Readability in g | Maximum weighing range in g | Weight of plunger in g | Calibration value in g | Minimum load in g |
|------------|---------------------|--------------------------------|---------------------------|---------------------------|----------------------|
| EW-2200 | 0.01 | 2200 incl. plunger | 850 | 0.1 | 0.5 |
| EW-4200 | 0.01 | 4200 incl. plunger | 850 | 0.1 | 0.5 |
| EW-6200 | 0.01 | 6200 incl. plunger | 850 | - | 1.0 |
| EW-12000 | 0.10 | 12000 incl. plunger | 850 | 1.0 | 5.0 |



4 scales available for different maximum weights and scaling ranges

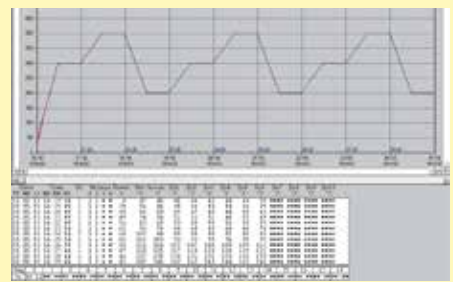

Software for documentation of the temperature curve and combustion loss using a PC



High-quality molybdenum disilicide heating elements

High-Temperature Furnaces with Molybdenum Disilicide Heating Elements with Fiber Insulation up to 1800 °C

Due to their solid construction and compact stand-alone design, these high-temperature furnaces are perfect for processes in the laboratory where the highest precision is needed. Outstanding temperature uniformity and practical details set very high quality benchmarks. For configuration for your processes, these furnaces can be extended with extras from our extensive option list.



High-temperature furnace HT 16/17

Standard Equipment

- Tmax 1600 °C, 1750 °C, or 1800 °C
- Recommended working temperature 1750 °C (for models HT ../18), increased wear and tear must be expected in case of working at higher temperatures
- Dual shell housing with fan cooling for low shell temperatures
- Heating from both sides via molybdenum disilicide heating elements
- High-quality fiber insulation backed by special insulation
- Side insulation constructed with tongue and groove blocks provides for low heat loss to the outside
- Long-life roof insulation with special suspension
- Chain-guided parallel swivel door for defined opening and closing of the door
- Two-door design (front/back) for high-temperature furnaces from HT 276/..
- Labyrinth sealing ensures the least possible temperature loss in the door area
- Reinforced floor as protection for bottom insulation as standard from models HT 16/16 upwards (distributed load 5 kg/dm²)
- Vapor vent in the furnace roof with motorized exhaust air flaps, controlled via the extra function of the controller
- Heating elements switched via thyristors

Additional Equipment

- Cooling system to cool the furnace with a defined temperature gradient or with a preset fresh air volume. Both operating modes can be switched on and off for different segments by means of the extra function of the controller.
- Safety package for debinding in air. Debinding technical ceramics is a critical process because of the hydrocarbons that are released. Hydrocarbons are flammable and there is a risk that a flammable mixture could form inside the furnace. Nabertherm offers tailored safety packages with respect to the process and the volume of binder that allow the furnace to be operated safely.
- Special heating elements for zirconia sintering
- Protective gas connection to purge with non-flammable protective or reaction gases
- Automatic gas supply system with solenoid valve and rotameter, controlled by the extra function of the controller
- Inner process box to improve the gas tightness and to protect the furnace chamber against contamination
- Refractory brick floor insulation for a higher floor load (Tmax 1700 °C)
- Lift door
- Automatic door lock incl. door contact switch
- Ethernet interface



High-temperature furnace HT 64/16S with lift door



High-temperature furnace HT 160/17 with gas supply system



High-temperature furnace HT 64/17 DB100-2 with safety package for debinding

| Model | Tmax °C | Inner dimensions in mm | | | Volume in l | Outer dimensions ¹ in mm | | | Connected load kW | Electrical connection* | Weight in kg |
|-----------|------------|------------------------|------|-----|----------------|-------------------------------------|------|------|----------------------|---------------------------|-----------------|
| | | w | d | h | | W | D | H | | | |
| HT 08/16 | 1600 | 150 | 300 | 150 | 8 | 740 | 640 | 1755 | 8.5 | 3-phase ² | 215 |
| HT 16/16 | 1600 | 200 | 300 | 260 | 16 | 820 | 690 | 1860 | 12.5 | 3-phase ² | 300 |
| HT 29/16 | 1600 | 275 | 300 | 350 | 29 | 985 | 740 | 1990 | 9.8 | 3-phase ² | 340 |
| HT 40/16 | 1600 | 300 | 350 | 350 | 40 | 1010 | 800 | 1990 | 12.5 | 3-phase | 420 |
| HT 64/16 | 1600 | 400 | 400 | 400 | 64 | 1140 | 890 | 2040 | 18.5 | 3-phase | 555 |
| HT 128/16 | 1600 | 400 | 800 | 400 | 128 | 1140 | 1280 | 2040 | 26.5 | 3-phase | 820 |
| HT 160/16 | 1600 | 500 | 550 | 550 | 160 | 1250 | 1040 | 2240 | 21.5 | 3-phase | 880 |
| HT 276/16 | 1600 | 500 | 1000 | 550 | 276 | 1310 | 1600 | 2290 | 36.5 | 3-phase | 1300 |
| HT 450/16 | 1600 | 500 | 1150 | 780 | 450 | 1360 | 1800 | 2570 | 65.0 | 3-phase | 1450 |
| HT 08/17 | 1750 | 150 | 300 | 150 | 8 | 740 | 640 | 1755 | 8.5 | 3-phase ² | 215 |
| HT 16/17 | 1750 | 200 | 300 | 260 | 16 | 820 | 690 | 1860 | 12.5 | 3-phase ² | 300 |
| HT 29/17 | 1750 | 275 | 300 | 350 | 29 | 985 | 740 | 1990 | 9.8 | 3-phase ² | 340 |
| HT 40/17 | 1750 | 300 | 350 | 350 | 40 | 1010 | 800 | 1990 | 12.5 | 3-phase | 420 |
| HT 64/17 | 1750 | 400 | 400 | 400 | 64 | 1140 | 890 | 2040 | 18.5 | 3-phase | 555 |
| HT 128/17 | 1750 | 400 | 800 | 400 | 128 | 1140 | 1280 | 2040 | 26.5 | 3-phase | 820 |
| HT 160/17 | 1750 | 500 | 550 | 550 | 160 | 1250 | 1040 | 2240 | 21.5 | 3-phase | 880 |
| HT 276/17 | 1750 | 500 | 1000 | 550 | 276 | 1310 | 1600 | 2290 | 36.5 | 3-phase | 1300 |
| HT 450/17 | 1750 | 500 | 1150 | 780 | 450 | 1360 | 1800 | 2570 | 65.0 | 3-phase | 1450 |
| HT 08/18 | 1800 | 150 | 300 | 150 | 8 | 740 | 640 | 1755 | 8.5 | 3-phase ² | 215 |
| HT 16/18 | 1800 | 200 | 300 | 260 | 16 | 820 | 690 | 1860 | 12.5 | 3-phase ² | 300 |
| HT 29/18 | 1800 | 275 | 300 | 350 | 29 | 985 | 740 | 1990 | 9.8 | 3-phase ² | 340 |
| HT 40/18 | 1800 | 300 | 350 | 350 | 40 | 1010 | 800 | 1990 | 12.5 | 3-phase | 420 |
| HT 64/18 | 1800 | 400 | 400 | 400 | 64 | 1140 | 890 | 2040 | 18.5 | 3-phase | 555 |
| HT 128/18 | 1800 | 400 | 800 | 400 | 128 | 1140 | 1280 | 2040 | 26.5 | 3-phase | 820 |
| HT 160/18 | 1800 | 500 | 550 | 550 | 160 | 1250 | 1040 | 2240 | 21.5 | 3-phase | 880 |
| HT 276/18 | 1800 | 500 | 1000 | 550 | 276 | 1310 | 1600 | 2290 | 36.5 | 3-phase | 1300 |
| HT 450/18 | 1800 | 500 | 1150 | 780 | 450 | 1360 | 1800 | 2570 | 65.0 | 3-phase | 1450 |

¹External dimensions vary when furnace is equipped with additional equipment. Dimensions on request.

²Heating only between two phases

*Please see page 75 for more information about supply voltage



Automatic gas supply system with solenoid valve and rotameter



Two-door design for high-temperature furnaces > HT 276/..



Reinforced floor as protection for bottom insulation for high-temperature furnace HT 16/16 and higher

High-Temperature Furnaces with SiC Rod Heating up to 1550 °C

The high-temperature furnaces HTC 16/16 - HTC 450/16 are heated by vertically hung SiC rods, which makes them especially suitable for sintering processes up to a maximum operating temperature of 1550 °C. For some processes, e.g. for sintering zirconium oxide, the absence of interactivity between the charge and the SiC rods, these models are more suitable than the alternatives heated with molybdenum disilicide elements. The basic construction of these furnaces make them comparable with the already familiar models in the HT product line and they can be upgraded with the same additional equipment.



High-temperature furnace HTC 160/16

Standard Equipment

- Tmax 1550 °C
- Dual shell housing with fan cooling for low shell temperatures
- Heating from both sides via vertically mounted SiC rods
- High-quality fiber insulation backed by special insulation
- Side insulation constructed with tongue and groove blocks provides for low heat loss to the outside
- Long-life roof insulation with special suspension
- Chain-guided parallel swivel door for defined opening and closing of the door without destroying the insulation
- Two-door design (front/back) for high-temperature furnaces > HTC 276/..
- Labyrinth sealing ensures the least possible temperature loss in the door area
- Reinforced floor as protection for bottom insulation
- Vapor vent in the furnace roof with motorized exhaust air flaps, controlled via the extra function of the controller
- Heating elements switched via SCR's
- Over-temperature limiter with adjustable cutout temperature as temperature limiter to protect the oven and load

Additional Equipment like HT models see page 39

| Model | Tmax in °C | Inner dimensions in mm | | | Volume in l | Outer dimensions ¹ in mm | | | Heating Power in kW | Connected load in kW | Electrical connection* | Weight in kg |
|------------|---------------|------------------------|------|-----|----------------|-------------------------------------|------|------|------------------------|-------------------------|---------------------------|-----------------|
| | | w | d | h | | W | D | H | | | | |
| HTC 16/16 | 1550 | 200 | 300 | 260 | 16 | 810 | 700 | 1500 | 12.0 | 16.0 | 3-phase ² | 270 |
| HTC 40/16 | 1550 | 300 | 350 | 350 | 40 | 1000 | 800 | 1620 | 12.0 | 16.1 | 3-phase | 380 |
| HTC 64/16 | 1550 | 400 | 400 | 400 | 64 | 1130 | 900 | 1670 | 18.0 | 41.1 | 3-phase | 550 |
| HTC 128/16 | 1550 | 400 | 800 | 400 | 128 | 1130 | 1290 | 1670 | 26.0 | 60.4 | 3-phase | 750 |
| HTC 160/16 | 1550 | 500 | 550 | 550 | 160 | 1250 | 1050 | 1900 | 21.0 | 39.2 | 3-phase | 800 |
| HTC 276/16 | 1550 | 500 | 1000 | 550 | 276 | 1300 | 1600 | 1900 | 36.0 | 72.5 | 3-phase | 1100 |
| HTC 450/16 | 1550 | 500 | 1150 | 780 | 450 | 1350 | 1740 | 2120 | 64.0 | 118.0 | 3-phase | 1500 |

¹External dimensions vary when furnace is equipped with additional equipment. Dimensions on request.
²Heating only between two phases

*Please see page 75 for more information about supply voltage



Vertically mounted SiC rods and optional perforated air inlet tubes of the debinding system in a high-temperature furnace



Automatic gas supply system



Two-door design for high-temperature furnaces > HT 276/..

High Temperature Furnaces with Molybdenum Disilicide Heating Elements with Refractory Brick Insulation up to 1700 °C

The high-temperature furnaces HFL 16/16 HFL 160/17 are characterized by their lining with robust light refractory bricks. This version is recommended for processes producing aggressive gases or acids, such as under glass melting.



High-temperature furnace HFL 16/17 DB50

Standard Equipment

Like high-temperature furnaces HT (see page 39), except:

- Tmax 1600 °C or 1700 °C
- Robust refractory brick insulation and special backing insulation
- Furnace floor made of lightweight refractory bricks accommodates high charge weights
- Chain-guided parallel swivel door for defined opening and closing of the door without destroying the insulation
- Labyrinth sealing ensures the least possible temperature loss in the door area

Additional Equipment

Like high-temperature furnaces HT see page 39

- Protective gas connection to purge with non-flammable protective or reaction gases
- Automatic gas supply system with solenoid valve and rotameter, controlled by the extra function of the controller
- Lift door

| Model | Tmax in °C | Inner dimensions in mm | | | Volume in l | Outer dimensions ¹ in mm | | | Connected load in kW | Electrical connection* | Weight in kg |
|------------|---------------|------------------------|-----|-----|----------------|-------------------------------------|------|------|-------------------------|---------------------------|-----------------|
| | | w | d | h | | W | D | H | | | |
| HFL 16/16 | 1600 | 200 | 300 | 260 | 16 | 1000 | 890 | 1620 | 12 | 3-phase ² | 500 |
| HFL 40/16 | 1600 | 300 | 350 | 350 | 40 | 1130 | 915 | 1890 | 12 | 3-phase | 660 |
| HFL 64/16 | 1600 | 400 | 400 | 400 | 64 | 1230 | 980 | 1940 | 18 | 3-phase | 880 |
| HFL 160/16 | 1600 | 500 | 550 | 550 | 160 | 1400 | 1250 | 2100 | 21 | 3-phase | 1140 |
| HFL 16/17 | 1700 | 200 | 300 | 260 | 16 | 1000 | 890 | 1620 | 12 | 3-phase ² | 530 |
| HFL 40/17 | 1700 | 300 | 350 | 350 | 40 | 1130 | 915 | 1890 | 12 | 3-phase | 690 |
| HFL 64/17 | 1700 | 400 | 400 | 400 | 64 | 1230 | 980 | 1940 | 18 | 3-phase | 920 |
| HFL 160/17 | 1700 | 500 | 550 | 550 | 160 | 1400 | 1250 | 2100 | 21 | 3-phase | 1190 |

¹External dimensions vary when furnace is equipped with additional equipment. Dimensions on request.

²Heating only between two phases

*Please see page 75 for more information about supply voltage



Automatic gas supply system



Thermocouple port in the ceiling with tripod



Light-weight refractory bricks and heating elements made from molybdenum disilicide

Tube Furnaces up to 1800 °C

An extensive range of accessories for flexible and universal use for different processes is available for these tube furnaces.



Dual shell housing made of textured stainless steel sheets with additional fan cooling for low surface temperature



Solid state relays provide for low noise operation



Exclusive use of insulation materials without categorization according to EC Regulation No 1272/2008 (CLP). This explicitly means that aluminosilicate wool, also known as “refractory ceramic fiber” (RCF), which is classified and possibly carcinogenic, is not used.



NTLog Basic for Nabertherm controller: recording of process data with USB-flash drive



Defined application within the constraints of the operating instructions



As additional equipment: Process control and documentation via VCD software package for monitoring, documentation and control



| Furnace Group | Model | Page |
|---|------------|------|
| Compact tube furnaces up to 1300 °C | RD, R | 44 |
| Split-type tube furnaces for horizontal or vertical operation up to 1300 °C | RSH, RSV | 46 |
| Rotary tube furnaces for batch operation up to 1100 °C | RSRB | 48 |
| Rotary tube furnaces for processes with continuous movement up to 1300 °C | RSRC | 50 |
| Tube furnaces with stand for horizontal and vertical operation up to 1500 °C | RT | 52 |
| High-temperature tube furnaces with SiC rod heating up to 1500 °C | RHTC | 53 |
| High-temperature tube furnaces for horizontal or vertical operation up to 1800 °C | RHTH, RHTV | 54 |
| Working tubes | | 56 |
| Gas supply systems/vacuum operation | | 58 |
| Control alternatives for tube furnaces | | 62 |
| Customized tube furnaces | | 63 |

Compact Tube Furnaces up to 1100 °C

The RD 30/200/11 tube furnace impresses with its very good price-performance ratio, particularly compact external dimensions and its low weight. This all-rounder is equipped with a working tube, which also serves as support for the heating wires. The working tube is therefore part of the furnace heating, with the advantage that the tube furnace reaches very high heating speeds. The furnace is designed for horizontal use up to 1100 °C.



Tube furnace RD 30/200/11

Standard Equipment

- Tmax 1100 °C
- Inner diameter of the tube: 30 mm, heated length: 200 mm
- Ceramic working tube C 530 including two fiber plugs for operation under air
- Thermocouple type K (1100 °C)
- Heating wires wound directly around the working tube resulting in very fast heat-up rates
- Controller R7, alternative controllers see page 78

Additional Equipment

- Over-temperature limiter with adjustable cutout temperature as temperature limiter to protect the oven and load
- Gas supply system 1 for non-flammable protective or reactive gas see page 58

| Model | Tmax ¹ in °C | Outer dimensions ² in mm | | | Inner tube Ø in mm | Heated length in mm | Length constant temperature ¹ +/- 5 K in mm | Connected load in kW | Heating time ³ in min | Electrical connection* | Weight in kg |
|--------------|----------------------------|-------------------------------------|-----|-----|-----------------------|------------------------|---|-------------------------|-------------------------------------|---------------------------|-----------------|
| | | W | D | H | | | | | | | |
| RD 30/200/11 | 1100 | 350 | 200 | 350 | 30 | 200 | 65 | 1.5 | 20 | 1-phase | 12 |

¹Values outside the tube. Difference to temperature inside the tube up to + 50 K

²External dimensions vary when furnace is equipped with additional equipment. Dimensions on request.

³Heating time of the empty and closed furnace up to Tmax - 100 K (connected to 230 V 1/N/PE)

*Please see page 75 for more information about supply voltage



Controller R7



Gas panel for one non-flammable protective or reactive gas (N₂, Ar, He, CO₂, air, forming gas)



Example of an over-temperature limiter

Compact Tube Furnaces up to 1300 °C

These compact tube furnaces with integrated control systems can be used universally for many processes. Equipped with a standard working tube of C 530 ceramic and two fiber plugs, these tube furnaces have a very good price/performance ratio.



Tube furnace R 170/1000/13



Tube furnace R 50/250/13 with gas supply system 2

Standard Equipment

- Tmax 1200 °C or 1300 °C
- Single-zoned design
- Outer tube diameter of 50 mm to 170 mm, heated length from 250 mm to 1000 mm
- Ceramic working tube C 530 including two fiber plugs for operation under air see page 56
- Thermocouple type N (1200 °C) or type S (1300 °C)
- Heating elements on support tubes provide for free radiation see page 62
- Controller B510 (5 programs with each 4 segments), alternative controllers see page 78

Additional Equipment

- Over-temperature limiter with adjustable cutout temperature as temperature limiter to protect the oven and load
- Charge control with temperature measurement in the working tube see page 62
- Three-zoned design (heated length from 500 mm) for optimization of temperature uniformity
- Alternative working tubes see page 56
- Gas supply systems 1, 15, 2, 3 or 4 see page 58

| Model | Tmax ¹ | Outer dimensions ³ in mm | | | Outer tube Ø in mm | Heated length in mm | Length constant ¹ temperature +/- 5 K in mm | | Tube length in mm | Connected load in kW | Electrical connection* | Weight in kg |
|---------------|-------------------|-------------------------------------|-----|-----|-----------------------|---------------------------|---|-------------|----------------------|----------------------------|---------------------------|-----------------|
| | in °C | W ² | D | H | | | single-zoned | three-zoned | | | | |
| R 50/250/12 | 1200 | 434 | 340 | 508 | 50 | 250 | 80 | - | 450 | 1.6 | 1-phase | 22 |
| R 50/500/12 | 1200 | 670 | 340 | 508 | 50 | 500 | 170 | 250 | 700 | 2.3 ⁴ | 1-phase | 34 |
| R 120/500/12 | 1200 | 670 | 410 | 578 | 120 | 500 | 170 | 250 | 700 | 6.5 | 3-phase | 44 |
| R 170/750/12 | 1200 | 920 | 460 | 628 | 170 | 750 | 250 | 375 | 1070 | 10.0 | 3-phase | 74 |
| R 170/1000/12 | 1200 | 1170 | 460 | 628 | 170 | 1000 | 330 | 500 | 1400 | 11.5 | 3-phase | 89 |
| R 50/250/13 | 1300 | 434 | 340 | 508 | 50 | 250 | 80 | - | 450 | 1.6 | 1-phase | 22 |
| R 50/500/13 | 1300 | 670 | 340 | 508 | 50 | 500 | 170 | 250 | 700 | 2.3 ⁴ | 1-phase | 34 |
| R 120/500/13 | 1300 | 670 | 410 | 578 | 120 | 500 | 170 | 250 | 700 | 6.5 | 3-phase | 44 |
| R 170/750/13 | 1300 | 920 | 460 | 628 | 170 | 750 | 250 | 375 | 1070 | 10.0 | 3-phase | 74 |
| R 170/1000/13 | 1300 | 1170 | 460 | 628 | 170 | 1000 | 330 | 500 | 1400 | 11.5 | 3-phase | 89 |

¹Values outside the tube. Difference to temperature inside the tube up to + 50

²Without tube

³External dimensions vary when furnace is equipped with additional equipment. Dimensions on request.

*Please see page 75 for more information about supply voltage

⁴Only valid for single-zone version



Tube furnace R 50/500/12 with three zone control



Gas panel for one non-flammable protective or reactive gas (N₂, Ar, He, CO₂, air, forming gas)

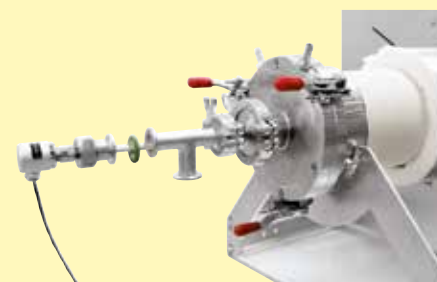

Thermocouple for charge control

Split-Type Tube Furnaces for Horizontal or Vertical Operation up to 1300 °C

These tube furnaces can be used for horizontal (RSH) or vertical (RSV) operation. The split-type design makes it easy to change the working tube. It allows for a comfortable exchange of various working tubes (e.g. working tubes made of different materials).

Using a wide range of accessories, these professional tube furnaces can be optimally tailored for your process. By adding different gas supply packages, you can work in a protective gas atmosphere, with gases or in a vacuum. In addition to the convenient standard controllers, modern PLC controls can also be used to control the process.



Tube furnace RSH 50/500/13

Standard Equipment

- Tmax 1100 °C or 1300 °C
- Single-zoned design
- RSV models with frame for vertical operation
- Split-type design for simple insertion of the working tube (opening temperature < 180 °C)
- Ceramic working tube C 530 including two fiber plugs for operation under air see page 56
- Thermocouple type N (1100 °C) or type S (1300 °C)
- Heating elements on support tubes provide for free radiation see page 62
- RSH: switchgear and control unit integrated in furnace housing
- RSV: switchgear and control unit separate from furnace in own wall or standing cabinet
- Controller B510, alternative controllers see page 78



Tube furnace RSV 170/1000/11 with gas-tight quartz glass working tube and water-cooled vacuum flanges

Additional Equipment

- Charge control with temperature measurement in the working tube see page 62
- Three-zone control for optimization of temperature uniformity see page 62
- Alternative working tubes see chart page 56
- Cooling systems for accelerated cooling of the working tube and charge
- Gas supply systems 1, 15 or 2 for non-flammable protective or reactive gas operation see page 58
- Gas supply packages 3 or 4 for hydrogen operation see page 60
- Vacuum package to evacuate the working tube see page 61



Tube furnace RSH 120/750/13 with gas supply system 4 for hydrogen applications

| Model | Tmax ¹ in °C | Outer dimensions ² in mm | | | Max. outer tube Ø in mm | Heated length in mm | Length constant temperature ¹ +/- 5 K in mm | | Tube length in mm | Connected load ⁴ in kW | | Electrical connection ⁵ | Weight in kg |
|-----------------|----------------------------|-------------------------------------|-----|------|----------------------------|------------------------|--|-------------|----------------------|-----------------------------------|---------|------------------------------------|-----------------|
| | | W ³ | D | H | | | single zoned | three zoned | | 1100 °C | 1300 °C | | |
| RSH 50/250/.. | | 420 | 375 | 510 | 50 | 250 | 80 | - | 650 | 1.9 | 1.9 | 1-phase | 25 |
| RSH 50/500/.. | | 670 | 375 | 510 | 50 | 500 | 170 | 250 | 850 | 3.4 | 3.4 | 1-phase ⁵ | 36 |
| RSH 80/500/.. | | 670 | 445 | 580 | 80 | 500 | 170 | 250 | 850 | 6.6 | 6.6 | 3-phase ⁵ | 46 |
| RSH 80/750/.. | 1100 | 920 | 495 | 630 | 80 | 750 | 250 | 375 | 1100 | 10.6 | 12.0 | 3-phase ⁵ | 76 |
| RSH 120/500/.. | or | 670 | 445 | 580 | 120 | 500 | 170 | 250 | 850 | 6.6 | 6.6 | 3-phase ⁵ | 46 |
| RSH 120/750/.. | 1300 | 920 | 495 | 630 | 120 | 750 | 250 | 375 | 1100 | 10.6 | 12.0 | 3-phase ⁵ | 76 |
| RSH 120/1000/.. | | 1170 | 495 | 630 | 120 | 1000 | 330 | 500 | 1350 | 13.7 | 13.7 | 3-phase ⁵ | 91 |
| RSH 170/750/.. | | 920 | 495 | 630 | 170 | 750 | 250 | 375 | 1100 | 10.6 | 12.0 | 3-phase ⁵ | 76 |
| RSH 170/1000/.. | | 1170 | 495 | 630 | 170 | 1000 | 330 | 500 | 1350 | 13.7 | 13.7 | 3-phase ⁵ | 91 |
| RSV 50/250/.. | | 545 | 590 | 975 | 50 | 250 | 80 | - | 650 | 1.9 | 1.9 | 1-phase | 25 |
| RSV 50/500/.. | | 545 | 590 | 1225 | 50 | 500 | 170 | 250 | 850 | 3.4 | 3.4 | 3-phase ⁵ | 36 |
| RSV 80/500/.. | | 615 | 590 | 1225 | 80 | 500 | 170 | 250 | 850 | 6.6 | 6.6 | 3-phase ⁵ | 46 |
| RSV 80/750/.. | 1100 | 665 | 590 | 1475 | 80 | 750 | 250 | 375 | 1100 | 10.6 | 12.0 | 3-phase ⁵ | 76 |
| RSV 120/500/.. | or | 615 | 590 | 1225 | 120 | 500 | 170 | 250 | 850 | 6.6 | 6.6 | 3-phase ⁵ | 46 |
| RSV 120/750/.. | 1300 | 665 | 590 | 1475 | 120 | 750 | 250 | 375 | 1100 | 10.6 | 12.0 | 3-phase ⁵ | 76 |
| RSV 120/1000/.. | | 665 | 590 | 1725 | 120 | 1000 | 330 | 500 | 1350 | 13.7 | 13.7 | 3-phase ⁵ | 91 |
| RSV 170/750/.. | | 665 | 590 | 1475 | 170 | 750 | 250 | 375 | 1100 | 10.6 | 12.0 | 3-phase ⁵ | 76 |
| RSV 170/1000/.. | | 665 | 590 | 1725 | 170 | 1000 | 330 | 500 | 1350 | 13.7 | 13.7 | 3-phase ⁵ | 91 |

¹Values outside the tube. Difference to temperature inside the tube up to + 50 K

²External dimensions vary when furnace is equipped with additional equipment. Dimensions on request.

³Without tube

⁴At 415 volt

⁵At 3-phase execution an N conductor ist required (3/N/PE)

*Please see page 75 for more information about supply voltage



Tube furnace RSH 80/500/13 with gas tight tube and water-cooled flanges



RSH 120/500/13S with sliding furnace



RSH 210/1000/11S with quartz glass working tube and gas supply package 2

Rotary Tube Furnaces for Batch Operation up to 1100 °C

The rotary tube furnaces of the RSRB series are suited for batch operation. The rotation of the working tube ensures that the charge is in motion. Due to the shape of the quartz reactor with the tapered pipe ends the batch is kept in the rotary tube furnace and can be heat-treated an arbitrarily long time period time. A controlled heating to the temperature profiles is also possible.



Rotary tube furnace RSRB 80/500/11 as tabletop version for batch operation

Standard Equipment

- Tmax 1100 °C
- Single-zoned design
- Thermocouple type N
- Heating elements on support tubes provide for free radiation see page 62
- Tube furnace designed as table-top model with quartz glass reactor which opens on both sides, tapered ends
- Reactor is removed for emptying out of the rotary tube furnace. Beltless drive and hinged furnace housing (opening temperature < 180 °C) provide for very easy removal through
- Adjustable drive of approx. 1-40 rpm
- Controller B510 (5 programs with each 4 segments), alternative controllers see page 78

Additional Equipment

- Charge control with temperature measurement in the working tube see page 62
- Three-zone control for optimization of temperature uniformity see page 62
- Reactor open on both sides, made of quartz glass with knobs for better mixing of the charge in the tube
- Gas supply package 25 for operation under non-flammable protective or reaction gases with a gas-tight rotating outlet see page 59
- Gas supply packages 3 or 4 for hydrogen operation see page 60
- Vacuum package for evacuating the working tube, depending on the pump used up to 10^{-2} mbar see page 61
- Left/right tilting device for easier loading and unloading of the work tube
 - For filling, the furnace is tilted to the right to convey the batch into the furnace. After the heat treatment, the furnace is swiveled to the opposite side for emptying, in order to convey the product out of the reactor again. It is not necessary to remove the reactor.
 - Mixing reactor made of quartz glass with integrated blade for better mixing of the batch, closed on one side, large opening on the opposite side
 - Rotary tube furnace assembled on base with integrated switchgear and controller, incl. transport casters



Rotary tube furnace RSRB 120/750/11 S with tilting mechanism to the left/to the right



RSRB 170/1000/11 H₂ with gas supply package 4 for hydrogen application

| Model | Tmax ¹ in °C | Outer dimensions ² in mm (Table-top model) | | | Max. outer tube Ø in mm | Ø Terminal end in mm | Heated length in mm | Length constant Temperature ¹ +/- 5 K in mm | | Tube length in mm | Connected load in kW | Electrical connection [*] | Weight in kg |
|------------------|----------------------------|--|-----|-----|-------------------------------|----------------------------|---------------------------|--|-------------|----------------------|----------------------------|---------------------------------------|--------------------|
| | | W | D | H | | | | single zoned | three zoned | | | | |
| RSRB 80/500/11 | 1100 | 1145 | 475 | 390 | 76 | 28 | 500 | 170 | 250 | 1140 | 3.7 | 1-phase | 100 |
| RSRB 80/750/11 | 1100 | 1395 | 475 | 390 | 76 | 28 | 750 | 250 | 375 | 1390 | 4.9 | 3-phase ³ | 115 |
| RSRB 120/500/11 | 1100 | 1145 | 525 | 440 | 106 | 28 | 500 | 170 | 250 | 1140 | 5.1 | 3-phase ³ | 105 |
| RSRB 120/750/11 | 1100 | 1395 | 525 | 440 | 106 | 28 | 750 | 250 | 375 | 1390 | 6.6 | 3-phase ⁴ | 120 |
| RSRB 120/1000/11 | 1100 | 1645 | 525 | 440 | 106 | 28 | 1000 | 330 | 500 | 1640 | 9.3 | 3-phase ⁴ | 125 |

¹Values outside the tube. Difference to temperature inside the tube up to + 50 K

²External dimensions vary when furnace is equipped with additional equipment. Dimensions on request.

³Heating only between phase 1 and neutral

⁴Heating only between two phases

*Please see page 75 for more information about supply voltage



Gas tight closing plug for tubes made of quartz glass closed at one side as additional equipment



Gas tight rotating union with gas cooler and charge thermocouple

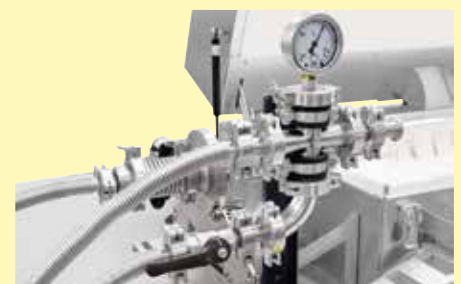

Connection set for vacuum operation

Rotary Tube Furnaces for Processes with Continuous Movement up to 1300 °C

The rotary tube furnaces of the RSRC series are particularly suitable for processes in which continuously running batch material is heated short-time. These rotary furnaces can be used very flexibly for various purposes. The rotary tube furnace is slightly inclined and brought to the target temperature. The material is then fed continuously at the top of the pipe. It passes through the heated zone of the tube and falls out of the pipe at the lower end. The time of the heat treatment depends on the angle of inclination, the speed of rotation and the length of the working tube, as well as from the flow properties of the batch material. Equipped with the optionally available closed feeding system, the rotary tube furnace can also be used for processes in a defined atmosphere or in a vacuum. Depending on the process, batch and required maximum temperature, work tubes made of different materials are used.



Rotary tube furnace RSRC 120750/13

Standard Equipment

- Tmax 1100 °C
 - Working tube made of quartz glass open at both sides
 - Thermocouple type N
- Tmax 1300 °C
 - Open ceramic tube C 530
 - Thermocouple type S
- Heating elements on support tubes provide for free radiation see page 62
- Adjustable drive of approx. 0.5-20 rpm
- Digital display unit for the tilting angle of the rotary tube furnace
- Split-type furnace housing (opening temperature < 180 °C) provide for easy tube change
- Compact system, rotary tube furnace positioned on a base frame with
 - Manual spindle drive with crank to set the tilting angle
 - Switchgear and controls integrated
 - Castors
- Controller B500 (5 programs with each 4 segments), alternative controllers see page 78

Additional Equipment

- Charge control with temperature measurement in the working tube see page 62
- Three-zone control for optimization of temperature uniformity see page 62
- Alternative work tubes for different process requirements see page 56
- Quartz glass batch reactors (Tmax 1100 °C)
- Higher temperatures up to 1500 °C available on request
- Vibrating channel on the rotary tube for convenient material supply, suitable for processes in air
- Powder discharge tube for easy material discharge, suitable for processes in air
- Feeding system for the continuous delivery of 5 liters of material under a defined atmosphere or vacuum, consisting of:
 - Stainless steel funnel incl. electric vibration unit to optimize the material feeding into the working tube
 - Electrically driven screw-conveyor at the inlet of the working tube with 10, 20 or 40 mm pitch and adjustable speed between 0.25 and 20 rpm
 - Collecting bottle made of laboratory glass at the outlet of the working tube
- Gas supply package 26 for operation under non-flammable protective or reaction gases (only in connection with the feeding system) see page 59
- Gas supply packages 3 or 4 for hydrogen applications (only in connection with feeding system) see page 60
- Vacuum package for evacuating the working pipe, depending on the pump used up to 10⁻² mbar see page 61

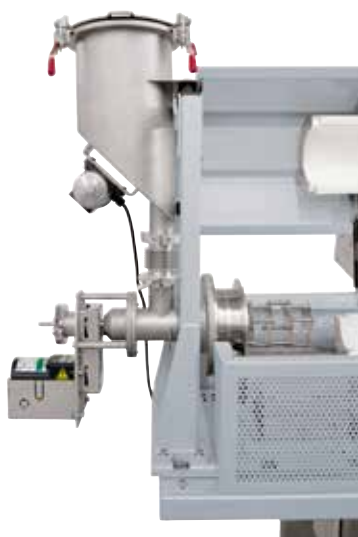

Vibration unit at the charging funnel for improved powder supply



Rotary tube furnace RSRC 80/500/11 with feeding system and gas supply system 26 for processes under protective gas

| Model | Tmax ¹ in °C | Outer dimensions ² in mm | | | Max. outer tube Ø in mm | Heated length in mm | Length constant | | Tube length in mm | Connected load in kW | Electrical connection* | Weight in kg |
|------------------|----------------------------|-------------------------------------|------|------|-------------------------------|---------------------------|--|-------------|----------------------|----------------------------|---------------------------|--------------------|
| | | W | D | H | | | Temperature ¹ +/- 5 K in mm single zoned | three zoned | | | | |
| RSRC 80/500/11 | 1100 | 2505 | 1045 | 1655 | 80 | 500 | 170 | 250 | 1540 | 3.7 | 1-phase | 555 |
| RSRC 80/750/11 | 1100 | 2755 | 1045 | 1655 | 80 | 750 | 250 | 375 | 1790 | 4.9 | 3-phase ³ | 570 |
| RSRC 120/500/11 | 1100 | 2505 | 1045 | 1715 | 110 | 500 | 170 | 250 | 1540 | 5.1 | 3-phase ³ | 585 |
| RSRC 120/750/11 | 1100 | 2755 | 1045 | 1715 | 110 | 750 | 250 | 375 | 1790 | 6.6 | 3-phase ³ | 600 |
| RSRC 120/1000/11 | 1100 | 3005 | 1045 | 1715 | 110 | 1000 | 330 | 500 | 2040 | 9.3 | 3-phase ⁴ | 605 |
| RSRC 80/500/13 | 1300 | 2505 | 1045 | 1655 | 80 | 500 | 170 | 250 | 1540 | 6.3 | 3-phase ⁴ | 555 |
| RSRC 80/750/13 | 1300 | 2755 | 1045 | 1655 | 80 | 750 | 250 | 375 | 1790 | 9.6 | 3-phase ⁴ | 570 |
| RSRC 120/500/13 | 1300 | 2505 | 1045 | 1715 | 110 | 500 | 170 | 250 | 1540 | 8.1 | 3-phase ⁴ | 585 |
| RSRC 120/750/13 | 1300 | 2755 | 1045 | 1715 | 110 | 750 | 250 | 375 | 1790 | 12.9 | 3-phase ⁴ | 600 |
| RSRC 120/1000/13 | 1300 | 3005 | 1045 | 1715 | 110 | 1000 | 330 | 500 | 2040 | 12.9 | 3-phase ⁴ | 605 |

¹Values outside the tube. Difference to temperature inside the tube up to + 50 K

²External dimensions vary when furnace is equipped with additional equipment. Dimensions on request.

³Heating only between phase 1 and neutral

⁴Heating only between two phases

*Please see page 75 for more information about supply voltage



Vibrating channel on the rotary tube for convenient material feeding

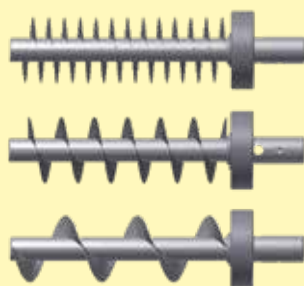

Screw-conveyors with different pitches

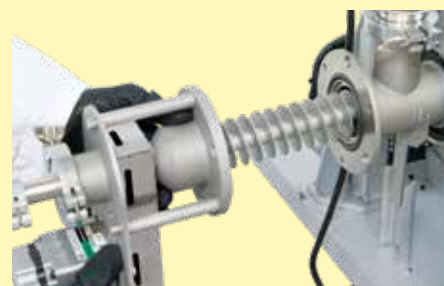

Screw-conveyor with variable speed

Tube Furnaces with Stand for Horizontal and Vertical Operation up to 1500 °C

These compact tube furnaces are used when laboratory experiments must be performed horizontally, vertically, or at specific angles. The ability to configure the angle of tilt and the working height, and their compact design, also make these tube furnaces suitable for integration into existing process systems.



Tube furnace RT 50/250/13

Standard Equipment

- Tmax 1100 °C, 1300 °C, or 1500 °C
- Compact design
- Vertical or horizontal operation infinitely adjustable
- Angle infinitely adjustable from 0° to 90°
- Working height infinitely adjustable
- Operation also possible without stand if safety guidelines are observed
- Ceramic working tube C 530 including two fiber plugs for operation under air
- Type S thermocouple
- Heating wires wound directly around the working tube resulting in very fast heat-up rates
- Control system integrated in furnace base
- Controller B510 (5 programs with each 4 segments), alternative controllers see page 78

Additional Equipment

- Over-temperature limiter with adjustable cutout temperature as temperature limiter to protect the oven and load
- Gas supply system 1 for non-flammable protective or reactive gas see page 58

| Model | Tmax ¹ in °C | Outer dimensions ² in mm | | | Inner tube Ø in mm | Heated length in mm | Length constant temperature ¹ +/- 5 K in mm | Tube length in mm | Connected load in kW | Electrical connection* | Weight in kg |
|--------------|----------------------------|-------------------------------------|-----|-----|-----------------------|---------------------------|--|----------------------|----------------------------|---------------------------|-----------------|
| | | W | D | H | | | | | | | |
| RT 50/250/11 | 1100 | 350 | 380 | 740 | 50 | 250 | 80 | 360 | 1.8 | 1-phase | 25 |
| RT 50/250/13 | 1300 | 350 | 380 | 740 | 50 | 250 | 80 | 360 | 1.8 | 1-phase | 25 |
| RT 30/200/15 | 1500 | 445 | 475 | 740 | 30 | 200 | 70 | 360 | 1.8 | 1-phase | 45 |

¹Values outside the tube. Difference to temperature inside the tube up to + 50 K

²External dimensions vary when furnace is equipped with additional equipment. Dimensions on request.

*Please see page 75 for more information about supply voltage

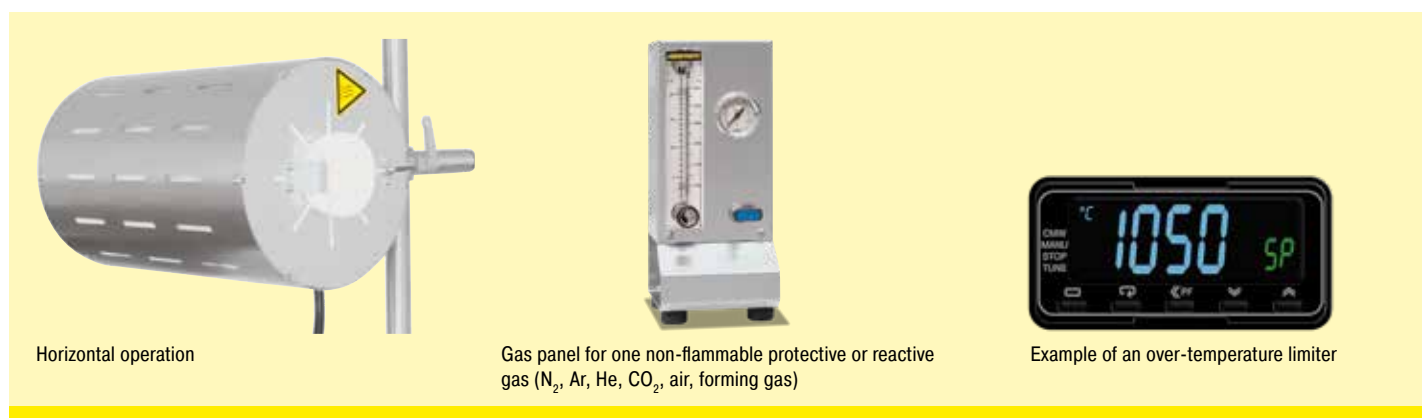

Horizontal operation

Gas panel for one non-flammable protective or reactive gas (N₂, Ar, He, CO₂, air, forming gas)

Example of an over-temperature limiter

High-Temperature Tube Furnaces with SiC Rod Heating up to 1500 °C

These compact tube furnaces with SiC rod heating and integrated switchgear with controller can be used universally for many processes. They represent an inexpensive variant in the high-temperature range. The standard mounting options for accessories make them flexible in use for a wide range of applications. The SiC heating elements arranged parallel to the working tube provide for an excellent temperature uniformity.



Tube furnace RHTC 80/450/15

Standard Equipment

- Tmax 1500 °C
- Active cooling of housing for low surface temperatures
- Ceramic working tube C 799 including two fiber plugs for operation under air see page 56
- Type S thermocouple
- SiC heating elements, easy to replace
- Controller B510 (5 programs with each 4 segments), alternative controllers see page 78

Additional Equipment

- Over-temperature limiter with adjustable cutout temperature as temperature limiter to protect the oven and load
- Charge control with temperature measurement in the working tube see page 62
- Alternative working tubes see page 56
- Gas supply systems 1, 2, 3 or 4 see page 58

| Model | Tmax ³ in °C | Outer dimensions ⁴ in mm | | | Outer tube Ø in mm | Heated length in mm | Length constant temperature ³ +/- 5 K in mm | Tube length in mm | Connected load in kW | Electrical connection* | Weight in kg |
|----------------|----------------------------|-------------------------------------|-----|-----|-----------------------|------------------------|---|----------------------|-------------------------|---------------------------|-----------------|
| | | W | D | H | | | | | | | |
| RHTC 80/230/15 | 1500 | 600 | 440 | 585 | 80 | 230 | 80 | 600 | 7.5 | 3-phase ² | 50 |
| RHTC 80/450/15 | 1500 | 820 | 440 | 585 | 80 | 450 | 150 | 830 | 11.3 | 3-phase ¹ | 70 |
| RHTC 80/710/15 | 1500 | 1075 | 440 | 585 | 80 | 710 | 235 | 1080 | 13.8 | 3-phase ¹ | 90 |

¹Values outside the tube. Difference to temperature inside the tube up to + 50 K

²External dimensions vary when furnace is equipped with additional equipment. Dimensions on request.

³Heating only between phase 1 and neutral

⁴Heating only between two phases

*Please see page 75 for more information about supply voltage

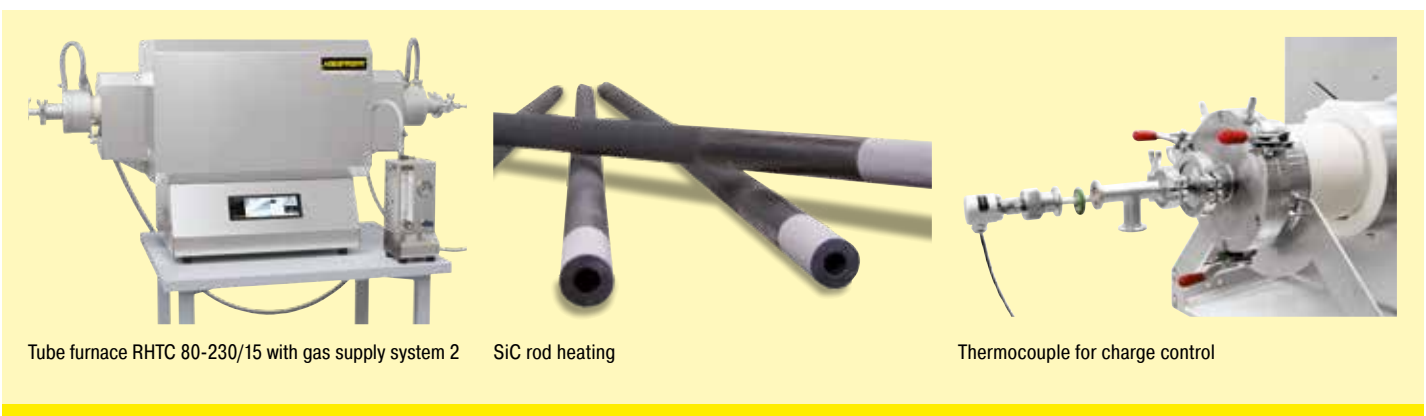

Tube furnace RHTC 80-230/15 with gas supply system 2

SiC rod heating

Thermocouple for charge control

High-Temperature Tube Furnaces for Horizontal or Vertical Operation up to 1800 °C

The high-temperature tube furnaces are available in either horizontal (type RHTH) or vertical (type RHTV) designs. High-quality insulation materials made of vacuum-formed fiber plates enable energy-saving operation due to low heat storage and heat conductivity. By using different gas supply systems, operations can be performed under non-flammable or flammable protective or reactive gases or under vacuum.



Tube furnace RHTV 50/150/17 with stand and gas supply system 2

Standard Equipment

- Tmax 1600 °C, 1700 °C, or 1800 °C
- Single-zoned design
- Insulation with vacuum-formed ceramic fiber plates
- Tube furnaces RHTV with frame for vertical operation
- Type B thermocouple
- Ceramic working tube C 799 including two fiber plugs for operation under air see page 56
- Hanging and easy to change MoSi₂ heating elements
- Power unit with low-voltage transformer and thyristor
- Over-temperature limiter with adjustable cutout temperature as temperature limiter to protect the oven and load and with selectable maximum temperature gradient as tube protection
- Switchgear and control unit separate from furnace in separate floor standing cabinet
- Controller P570 (50 programs with each 40 segments), alternative controllers see page 78

Additional Equipment

- Charge control with temperature measurement in the working tube see page 62
- Three-zone control for optimization of temperature uniformity (only horizontal tube furnaces RHTH) see page 62
- Alternative working tubes see page 56
- Gas supply system 2 for non-flammable protective or reactive gas operation see page 58
- Gas supply packages 3 or 4 for hydrogen operation see page 60
- Vacuum package to evacuate the working tube see page 61



RHTH 80/300/18 tube furnace with water-cooled flanges and charge control



RHTH 120/600/18 with gas supply system 4 for operation with hydrogen

| Model Horizontal design | Tmax ¹ in °C | Outer dimensions ³ in mm | | | Max. outer tube Ø in mm | Heated length in mm | Length constant temperature ¹ +/- 5 K in mm | | Tube length in mm | Connected load in kW | Electrical connection* | Weight in kg |
|----------------------------|----------------------------|-------------------------------------|-----|-----|-------------------------------|---------------------------|--|-------------|----------------------|----------------------------|---------------------------|-----------------|
| | | W ² | D | H | | | single zoned | three zoned | | | | |
| RHTH 50/150/.. | 1600 or | 470 | 480 | 640 | 50 | 150 | 50 | 70 | 380 | 5.4 | 3-phase ⁴ | 70 |
| RHTH 80/300/.. | 1700 or | 620 | 550 | 640 | 80 | 300 | 100 | 150 | 530 | 9.0 | 3-phase ⁴ | 90 |
| RHTH 120/600/.. | 1800 | 920 | 550 | 640 | 120 | 600 | 200 | 300 | 830 | 14.4 | 3-phase ⁴ | 110 |

| Model Vertical design | Tmax ¹ in °C | Outer dimensions ³ in mm | | | Max. outer tube Ø in mm | Heated length in mm | Length constant temperature ¹ +/- 5 K in mm | Tube length in mm | Connected load in kW | Electrical connection* | Weight in kg |
|--------------------------|----------------------------|-------------------------------------|-----|----------------|-------------------------------|---------------------------|--|----------------------|----------------------------|---------------------------|-----------------|
| | | W | D | H ² | | | | | | | |
| RHTV 50/150/.. | 1600 or | 500 | 650 | 510 | 50 | 150 | 30 | 380 | 5.4 | 3-phase ⁴ | 70 |
| RHTV 80/300/.. | 1700 or | 580 | 650 | 660 | 80 | 300 | 80 | 530 | 10.3 | 3-phase ⁴ | 90 |
| RHTV 120/600/.. | 1800 | 580 | 650 | 960 | 120 | 600 | 170 | 830 | 19.0 | 3-phase ⁴ | 110 |

¹Values outside the tube. Difference to temperature inside the tube up to + 50 K

²Without tube

³External dimensions vary when furnace is equipped with additional equipment. Dimensions on request.

⁴Heating only between two phases

*Please see page 75 for more information about supply voltage



Tube furnace RHTH 120/600/17



Sintering under hydrogen in a tube furnace of RHTH product line



Example of over-temperature limiter

Working Tubes

There are various working tubes available, depending on application and temperatures. The technical specifications of the different working tubes are presented in the following table:



| Material | Tube outside Ø in mm | Max. heat-up ramp in K/h | Tmax in air ³ in °C | Tmax in vacuum operation in °C | Gas tight |
|------------------------------------|----------------------|--------------------------|--------------------------------|--------------------------------|-----------|
| C 530 (Sillimantin) ¹ | < 120 from 120 | unlimited 200 | 1300 | not possible | no |
| C 610 (Pythagoras) ¹ | < 120 from 120 | 300 200 | 1400 | 1200 | yes |
| C 799 (Alsint 99.7 %) ¹ | < 120 from 120 | 300 200 | 1800 | 1400 | yes |
| Quartz glass ² | all | unlimited | 1100 | 950 | yes |
| FeCrAl-Alloy ² (APM) | all | unlimited | 1300 | 1100 | yes |

¹Tolerances with respect to form and position acc. to DIN 40680

²All dimensions are nominal dimensions, tolerances on request

³The max. allowed temperature might be reduced operating under aggressive atmospheres

Various working tubes as option

| Measurements outer Ø x inner Ø x length | Article No. ⁴ | | Rotary tube furnace, continuous operation | | | | | | | | | | Batch operation | | | | |
|--|--------------------------|------------|---|--------|---------|---------|----------|---------|--------|---------|---------|----------|-----------------|--------|---------|---------|----------|
| | work tube | spare tube | RSRC | | | | | | | | | | RSRB | | | | |
| | | | 1100 °C | | | | | 1300 °C | | | | | 1100 °C | | | | |
| | | | 80-500 | 80-750 | 120-500 | 120-750 | 120-1000 | 80-500 | 80-750 | 120-500 | 120-750 | 120-1000 | 80-500 | 80-750 | 120-500 | 120-750 | 120-1000 |
| Ceramic tube C 530 | | | | | | | | | | | | | | | | | |
| 80 x 65 x 1540 mm | 6000058702 | 691404536 | ○ | | | | | ● | | | | | | | | | |
| 80 x 65 x 1790 mm | 6000058701 | 691404537 | | ○ | | ○ | | | ● | | ○ | | | | | | |
| 80 x 65 x 2040 mm | 6000058700 | 691404538 | | | | | ○ | | | | | ○ | | | | | |
| 110 x 95 x 1540 mm | 6000058704 | 691404539 | | | ○ | | | | | ● | | | | | | | |
| 110 x 95 x 1790 mm | 6000058703 | 691403376 | | | | ○ | | | | | | ● | | | | | |
| 110 x 95 x 2040 mm | 6000058216 | 691404540 | | | | | ○ | | | | | | ● | | | | |
| Ceramic tube C 610 | | | | | | | | | | | | | | | | | |
| 80 x 65 x 1540 mm | 6000058707 | 691404541 | ○ | | | | | ○ | | | | | | | | | |
| 80 x 65 x 1790 mm | 6000058706 | 691404542 | | ○ | | ○ | | | ○ | | ○ | | | | | | |
| 80 x 65 x 2040 mm | 6000058705 | 691404543 | | | | | ○ | | | | | ○ | | | | | |
| 110 x 95 x 1540 mm | 6000058709 | 691404544 | | | ○ | | | | | | ○ | | | | | | |
| 110 x 95 x 1790 mm | 6000058708 | 691404561 | | | | ○ | | | | | | ○ | | | | | |
| 110 x 95 x 2040 mm | 6000052969 | 691403437 | | | | | ○ | | | | | | ○ | | | | |
| Quartz glass tube | | | | | | | | | | | | | | | | | |
| 76 x 70 x 1540 mm | 6000058947 | 691404545 | ● | | | | | ○ | | ○ | | | | | | | |
| 76 x 70 x 1790 mm | 6000054644 | 691404546 | | ● | | ○ | | | ○ | | ○ | | | | | | |
| 76 x 70 x 2040 mm | 6000058946 | 691404547 | | | | | ○ | | | | | ○ | | | | | |
| 106 x 100 x 1540 mm | 6000058949 | 691403519 | | | ● | | | | | | ○ | | | | | | |
| 106 x 100 x 1790 mm | 6000058948 | 691403305 | | | | ● | | | | | | ○ | | | | | |
| 106 x 100 x 2040 mm | 6000030741 | 691404548 | | | | | ● | | | | | | ○ | | | | |
| Quartz glass tube with pimple | | | | | | | | | | | | | | | | | |
| 76 x 70 x 1540 mm | 6000058953 | 691404549 | ○ | | | | | ○ | | | | | | | | | |
| 76 x 70 x 1790 mm | 6000058952 | 691404550 | | ○ | | ○ | | | ○ | | ○ | | | | | | |
| 76 x 70 x 2040 mm | 6000058951 | 691404551 | | | | | ○ | | | | | ○ | | | | | |
| 106 x 100 x 1540 mm | 6000058956 | 691404552 | | | ○ | | | | | | ○ | | | | | | |
| 106 x 100 x 1790 mm | 6000058955 | 691403442 | | | | ○ | | | | | | ○ | | | | | |
| 106 x 100 x 2040 mm | 6000058954 | 691404553 | | | | | ○ | | | | | | ○ | | | | |
| CrFeAl-Alloy | | | | | | | | | | | | | | | | | |
| 75 x 66 x 1540 mm | 601405296 | 691405357 | ○ | | ○ | | | ○ | | ○ | | | | | | | |
| 75 x 66 x 1790 mm | 601405297 | 691405231 | | ○ | | ○ | | | ○ | | ○ | | | | | | |
| 109 x 99 x 1540 mm | 601405298 | 691403682 | | | ○ | | | | | ○ | | | | | | | |
| 109 x 99 x 1790 mm | 601405299 | 691403607 | | | | ○ | | | | | | ○ | | | | | |
| 109 x 99 x 2040 mm | 601405300 | 691405122 | | | | | ○ | | | | | | ○ | | | | |
| Quartz glass reactor | | | | | | | | | | | | | | | | | |
| 76 x 70 x 1140 mm | 601402746 | 691402548 | | | | | | | | | | | ● | | ○ | | |
| 76 x 70 x 1390 mm | 601402747 | 691402272 | | | | | | | | | | | | ● | | ○ | |
| 106 x 100 x 1140 mm | 601402748 | 691402629 | | | | | | | | | | | | | ● | | |
| 106 x 100 x 1390 mm | 601402749 | 691402638 | | | | | | | | | | | | | | ● | |
| 106 x 100 x 1640 mm | 600048571 | 600032705 | | | | | | | | | | | | | | | ● |
| Quartz glass reactor with pimples | | | | | | | | | | | | | | | | | |
| 76 x 70 x 1140 mm | 601404723 | 691402804 | | | | | | | | | | | ○ | | ○ | | |
| 76 x 70 x 1390 mm | 601404724 | 691403429 | | | | | | | | | | | | ○ | | ○ | |
| 106 x 100 x 1140 mm | 601404725 | 691403355 | | | | | | | | | | | | | ○ | | |
| 106 x 100 x 1390 mm | 601404726 | 691403296 | | | | | | | | | | | | | | ○ | |
| Quartz glass mixing reactor | | | | | | | | | | | | | | | | | |
| 76 x 70 x 1140 mm | 601404727 | 691403407 | | | | | | | | | | | | ○ | | | |
| 76 x 70 x 1390 mm | 601404728 | 691404554 | | | | | | | | | | | | | ○ | | |
| 106 x 100 x 1140 mm | 601404732 | 691404557 | | | | | | | | | | | | | | ○ | |
| 106 x 100 x 1390 mm | 601404733 | 691404558 | | | | | | | | | | | | | | | ○ |

● Standard working tube

○ Working tube available as an option

⁴Tubes/reactors incl. mounted sleeves for connection to the rotary drive. Spare tubes come without sleeves.

| Working tube outer Ø x inner Ø x length | Article No. | Model | | | | | | | | | | | | | | | | | | | | | | | |
|--|-------------|--------|--------|---------|---------|----------|---------|--------|--------|--------|---------|---------|----------|---------|----------|--------|--------|--------|--------|--------|---------|--------|--------|---------|---|
| | | R | | | | | RSH/RSV | | | | | | | | RHTC | | | RHTH | | | RHTV | | | | |
| | | 50-250 | 50-500 | 120-500 | 170-750 | 170-1000 | 50-250 | 50-500 | 80-500 | 80-750 | 120-500 | 120-750 | 120-1000 | 170-750 | 170-1000 | 80-230 | 80-450 | 80-710 | 50-150 | 80-300 | 120-600 | 50-150 | 80-300 | 120-600 | |
| C 530 | | | | | | | | | | | | | | | | | | | | | | | | | |
| 40 x 30 x 450 mm | 692070274 | ○ | | | | | ○ | | | | | | | | | | | | | | | | | | |
| 40 x 30 x 700 mm | 692070276 | | ○ | ○ | | | ○ | ○ | | | ○ | | | | | | | | | | | | | | |
| 50 x 40 x 450 mm | 692070275 | ● | | | | | ● | | | | | | | | | | | | | | | | | | |
| 50 x 40 x 700 mm | 692070277 | | ● | ○ | | | | ○ | | | ○ | | | | | | | | | | | | | | |
| 60 x 50 x 850 mm | 692070305 | | | ○ | | | | ○ | | | ○ | | | | | | | | | | | | | | |
| 60 x 50 x 1100 mm | 692070101 | | | | ○ | | | | | | | | ○ | | | | | | | | | | | | |
| 80 x 70 x 850 mm | 692070108 | | | ○ | | | | ● | | | ○ | | | | | | | | | | | | | | |
| 80 x 70 x 1100 mm | 692070109 | | | | ○ | | | | ● | | | ○ | | | | | | | | | | | | | |
| 120 x 100 x 850 mm | 692070110 | | | ● | | | | | | ● | | | | | | | | | | | | | | | |
| 120 x 100 x 1100 mm | 692070111 | | | | ○ | | | | | | ● | | | | | | | | | | | | | | |
| 120 x 100 x 1350 mm | 692070131 | | | | | ○ | | | | | | ● | | | | | | | | | | | | | |
| 170 x 150 x 1100 mm | 692071659 | | | | ● | | | | | | | | ● | | | | | | | | | | | | |
| 170 x 150 x 1350 mm | 692071660 | | | | | ● | | | | | | | | ● | | | | | | | | | | | |
| Vacuum tube¹ C 610 | | | | | | | | | | | | | | | | | | | | | | | | | |
| 50 x 40 x 650 mm | 692070207 | ○ | | | | | ○ | | | | | | | | | | | | | | | | | | |
| 50 x 40 x 900 mm | 691405352 | | ○ | | | | | ○ | | | | | | | | | | | | | | | | | |
| 60 x 50 x 1230 mm | 692070180 | | | ○ | | | | | ○ | | ○ | | | | | | | | | | | | | | |
| 60 x 50 x 1480 mm | 692070181 | | | | ○ | | | | | ○ | | | | | | | | | | | | | | | |
| 80 x 70 x 1230 mm | 692070182 | | | ○ | | | | | ○ | | ○ | | | | | | | | | | | | | | |
| 80 x 70 x 1480 mm | 692070183 | | | | ○ | | | | | ○ | | | | | | | | | | | | | | | |
| 120 x 100 x 1230 mm | 692070184 | | | ○ | | | | | | ○ | | | | | | | | | | | | | | | |
| 120 x 100 x 1480 mm | 692070185 | | | | ○ | | | | | | ○ | | | | | | | | | | | | | | |
| 120 x 100 x 1730 mm | 692070186 | | | | | ○ | | | | | | ○ | | | | | | | | | | | | | |
| 170 x 150 x 1480 mm | 692070187 | | | | ○ | | | | | | | | ○ | | | | | | | | | | | | |
| 170 x 150 x 1730 mm | 692070188 | | | | | ○ | | | | | | | | ○ | | | | | | | | | | | |
| C 799 | | | | | | | | | | | | | | | | | | | | | | | | | |
| 50 x 40 x 380 mm | 692071664 | | | | | | | | | | | | | | | | | ● | | | | ● | | | |
| 50 x 40 x 450 mm | 691403622 | ○ | | | | | | | | | | | | | | | | | | | | | | | |
| 50 x 40 x 530 mm | 692071665 | | | | | | | | | | | | | | | | | | ○ | | | | ○ | | |
| 50 x 40 x 690 mm | 692071714 | | ○ | | | | | | | | | | | | | | | | | | | | | | |
| 50 x 40 x 830 mm | 692070163 | | | | | | | | | | | | | | | | | | | | | | | | |
| 80 x 70 x 530 mm | 692071669 | | | | | | | | | | | | | | | | | | | | | | | | |
| 80 x 70 x 600 mm | 692070600 | | | | | | | | | | | | | | | | | ● | | | | | | | |
| 80 x 70 x 830 mm | 692071670 | | | | | | | | | | | | | | | | | | ● | | | | | | |
| 80 x 70 x 1080 mm | 692071647 | | | | | | | | | | | | | | | | | | | ● | | | | | |
| 120 x 105 x 830 mm | 692071713 | | | | | | | | | | | | | | | | | | | | | ● | | | ● |
| Vacuum tube¹ C 799 | | | | | | | | | | | | | | | | | | | | | | | | | |
| 50 x 40 x 990 mm | 692070149 | | | | | | | | | | | | | | | | | | ○ | | | | ○ | | |
| 50 x 40 x 1140 mm | 692070176 | | | | | | | | | | | | | | | | | | | ○ | | | ○ | | |
| 50 x 40 x 1440 mm | 692070177 | | | | | | | | | | | | | | | | | | | | ○ | | | ○ | |
| 80 x 70 x 990 mm | 692070190 | | | | | | | | | | | | | | | | | ○ | | | | | | ○ | |
| 80 x 70 x 1140 mm | 692070148 | | | | | | | | | | | | | | | | | | | | | | | ○ | |
| 80 x 70 x 1210 mm | 692070191 | | | | | | | | ○ | | ○ | | | | | | | | ○ | | | | | ○ | |
| 80 x 70 x 1470 mm | 692070192 | | | | | | | | | ○ | | ○ | | | | | | | | ○ | | | | | |
| 80 x 70 x 1440 mm | 692070178 | | | | | | | | | | | | | | | | | | | | | | | ○ | |
| 120 x 105 x 1440 mm | 692070147 | | | | | | | | | | | | | | | | | | | | | | ○ | | ○ |
| APM vacuum tube² with grinded ends | | | | | | | | | | | | | | | | | | | | | | | | | |
| 51 x 38 x 650 mm | 691406358 | ● | | | | | ● | | | | | | | | | | | | | | | | | | |
| 51 x 38 x 900 mm | 691406359 | | ● | | | | | ● | | | | | | | | | | | | | | | | | |
| 51 x 38 x 1480 mm | 691406360 | | | | ○ | | | | | ○ | | | | | | | | | | | | | ○ | | |
| 51 x 38 x 1730 mm | 691406361 | | | | | ○ | | | | | | | | ○ | | | | | | | | | ○ | | |
| 60 x 52 x 1230 mm | 691406362 | | | ○ | | | | | | ○ | | ○ | | | | | | | | | | | | | |
| 60 x 52 x 1480 mm | 691406363 | | | | ○ | | | | | ○ | | ○ | | ○ | | | | | | | | | | | |
| 60 x 52 x 1730 mm | 691406364 | | | | | ○ | | | | | | | | ○ | | | | | | | | | | | ○ |
| 75 x 66 x 1230 mm | 691406206 | | | ○ | | | | | ● | | ○ | | | | | | | | | | | | | | |
| 75 x 66 x 1480 mm | 691406365 | | | | ○ | | | | | ● | | ○ | | ○ | | | | | | | | | | | |
| 75 x 66 x 1730 mm | 691406366 | | | | | ○ | | | | | | | ○ | | | | | | | | | | | | ○ |
| 115 x 104 x 1230 mm | 691406367 | | | ● | | | | | | | | ● | | | | | | | | | | | | | |
| 115 x 104 x 1480 mm | 691406325 | | | | ○ | | | | | | | ● | | | | | | | | | | | | | |
| 115 x 104 x 1730 mm | 691406368 | | | | | ○ | | | | | | | ● | | | | | | | | | | | ○ | |
| 164 x 152 x 1480 mm | 691406339 | | | | ● | | | | | | | | | ● | | | | | | | | | ● | | |
| 164 x 152 x 1730 mm | 691406370 | | | | | ● | | | | | | | | | ● | | | | | | | | | ● | |
| Vacuum quartz glass tube | | | | | | | | | | | | | | | | | | | | | | | | | |
| 50 x 40 x 650 mm | 691403182 | ○ | | | | | ○ | | | | | | | | | | | | | | | | | | |
| 50 x 40 x 900 mm | 691406024 | | ○ | | | | | ○ | | | | | | | | | | | | | | | | | |
| 60 x 54 x 1030 mm | 691404422 | | | | | | | | | | | | | | | | | | | | | | | | |
| 60 x 54 x 1230 mm | 691404423 | | | ○ | | | | | ○ | | ○ | | | | | | | | | | | | | | |
| 60 x 54 x 1480 mm | 691404424 | | | | ○ | | | | | ○ | | ○ | | | | | | | | | | | | | ○ |
| 80 x 74 x 1230 mm | 691404425 | | | ○ | | | | | ○ | | ○ | | | | | | | | | | | | | | |
| 80 x 74 x 1480 mm | 691404426 | | | | ○ | | | | | ○ | | ○ | | | | | | | | | | | | | ○ |
| 120 x 114 x 1230 mm | 691404427 | | | ○ | | | | | | | ○ | | | | | | | | | | | | | | |
| 120 x 114 x 1480 mm | 691404428 | | | | ○ | | | | | | | ○ | | | | | | | | | | | | | ○ |
| 120 x 114 x 1730 mm | 691404429 | | | | | ○ | | | | | | | ○ | | | | | | | | | | | | ○ |
| 170 x 162 x 1480 mm | 691404430 | | | | ○ | | | | | | | | | ○ | | | | | | | | | | | ○ |
| 170 x 162 x 1730 mm | 691404431 | | | | | ○ | | | | | | | | | ○ | | | | | | | | | | ○ |

● Standard working tube
○ Working tube available as an option

¹With ground tube ends for connection of water-cooled flanges
²With attached holder for gas tight flange

Gas Supply Systems/Vacuum Package for Tube Furnaces

When equipped with different gas supply systems, most tube furnace product lines can be adapted for operation with non-flammable or flammable gases or for vacuum operation.



Fiber plug with protective gas connection, suitable for many laboratory applications (gas supply system 1)

Gas Supply System 1

For Non-Flammable Protective or Reactive Gases in Static Tube Furnaces, not Gas-Tight

Gas supply system 1 is a basic version for static tube furnaces, for operation with non-flammable protective or reactive gases. This system is not completely gas-tight and can therefore not be used for vacuum operation.

Standard Equipment

- Available for RD, R, RT, RHTC, RSH and RSV tube furnaces
- Two plugs made of porous, non-classified ceramic fiber incl. protective gas connections
- The standard working tube supplied with the furnace can be used
- Gas panel for one non-flammable protective or reactive gas (N₂, Ar, He, CO₂, air, forming gas*)
- Shut-off valve and flow meter with manual valve
- Supply of gas with 300 mbar required

Additional Equipment

- Additional gas panels for further non-flammable gases
- Automatic segment-related switching on/off by a magnetic valve
- Bottle pressure reducer for use with bottled gas



Flange with heat radiation protection insert (gas supply system 15)

Gas Supply Systems 15 and 2

for Non-Flammable Protective or Reactive Gases in Static Tube Furnaces, Gas-Tight

For increased atmospheric purity requirements in the working tube in static tube furnaces we recommend one of these gas-tight gas supply systems with stainless steel flanges on the end of the tube is recommended.

The less expensive gas supply system 15 for furnaces up to 1300 °C and working tubes to 120 mm diameter is available for R, RSH and RSV tube furnaces. It includes contact protection on the flange and a stainless steel type 1.4301 heat radiation protection insert for the tube ends to protect the seals. A heat radiation protection package cools the flanges and a water connection is thus not required. With this variant, the tube must not be opened while it is hot. It is also not suitable for applications with a turbomolecular pump to achieve high vacuum. Gas supply system 2 is the correct choice for this type of application.

Gas supply system 2 with water-cooled flanges is available for R, RHTC, RHTH, RHTV, RSH and RSV furnaces. Cooling water supply with NW9 hose connector to be provided by the customer.

Standard Equipment

- Extended gas-tight working tube made of C 610 for furnaces up to 1300 °C or C 799 for temperatures above 1300 °C
- Two vacuum-tight stainless steel flanges with KF flange on the outlet side
- Mounting system on furnace for the flanges



Water-cooled vacuum flange (gas supply system 2)

* Country-specific regulations for permissible mixture ratios must be observed.

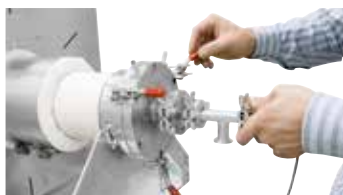

Water-cooled stainless steel flanges with quick locks as additional equipment



Window as additional equipment for gas-tight flanges

- Gas panel for one non-flammable protective or reactive gas (N_2 , Ar, He, CO_2 , air, forming gas*)
- Shut-off valve and flow meter with manual valve
- Supply of gas with 300 mbar required
- Check valve in the gas outlet to prevent air entering

Additional Equipment for Gas Supply Systems 15 and 2

- Additional gas panels for further non-flammable gases
- Automatic segment-related switching on/off by a magnetic valve
- Bottle pressure reducer for use with bottled gas
- Vacuum package for a maximum final pressure of up to 5×10^{-5} mbar

Other Additional Equipment only for Gas Supply System 2

- Quick-locks for water-cooled flanges
- Air-water heat exchanger for closed loop water circuit
- Window for charge observation

Gas Supply Systems 25 and 26

for Non-Flammable Protective or Reactive Gases in Rotary Tube Furnaces, Gas-Tight

Gas supply systems for non-flammable protective and reactive gases are also available for RSRB and RSRC rotary tube furnaces.



Gas panel for one non-flammable protective or reactive gas (N_2 , Ar, He, CO_2 , air, forming gas*)

Standard Equipment

- Gas panel for one non-flammable protective or reactive gas (N_2 , Ar, He, CO_2 , air, forming gas*)
- Shut-off valve and flow meter with manual valve
- Supply of gas with 300 mbar required

Gas supply system 25 for rotary tube furnaces for batch operation (RSRB) also includes gas-tight rotary lead-outs on the gas inlet and outlet as well as a gas cooler at the outlet. A check valve is also installed at the gas outlet to prevent air entering the tube.

For gas supply system 26 for rotary tube furnaces for continuous processes (RSRC) the furnace must also be equipped with a feeding system.

Additional Equipment

- Additional gas panels for further non-flammable gases
- Automatic segment-related switching on/off by a magnetic valve
- Bottle pressure reducer for use with bottled gas
- Vacuum package for a maximum final pressure of up to 5×10^{-2} mbar

* Country-specific regulations for permissible mixture ratios must be observed.

Gas Supply System 3 for Hydrogen Applications in Tube Furnaces above 750 °C

Gas supply system 3 allows for the operation in a hydrogen atmosphere at temperatures above 750 °C. From 750 °C, hydrogen can be introduced into the working tube. At program end or when the temperature falls below 750 °C, the working tube is purged with nitrogen to prevent the formation of an explosive hydrogen/oxygen atmosphere. The purging volume is at least five times the volume of the tube. Surplus hydrogen is burnt off in an exhaust gas torch.



Example of an over-temperature limiter

Standard Equipment

- Available for R, RHTC, RHTH, RHTV, RSH, RSV, RSRB and RSRC tube furnaces
- Gas panel for hydrogen and nitrogen
- Automatic segment-related switching on/off by a magnetic valve
- Nabertherm Controller to regulate the temperature curve and switch the gas supply system
- Additional safety controls with touch panel to monitor hydrogen gassing only above 750 °C
- Exhaust gas torch with temperature monitoring
- Over-temperature limiter with digital display as over-temperature protection for the furnace and charge
- Temperature monitoring at the gas inlet
- Emergency purge container for nitrogen



Gas panels with mass flow controllers

Additional Equipment

- Additional gas panels for further non-flammable gases
- Gassing via program-related controllable mass flow controllers
- Bottle pressure reducer for use with bottled gas
- Air-water heat exchanger for closed loop water circuit (not for RSRB and RSRC)

Gas Supply System 4 for Hydrogen Applications in Tube Furnaces from Room Temperature

Gas supply system 4 allows operation with a hydrogen atmosphere starting at ambient temperature. During hydrogen operation, a pressure of approx. 30 mbar is ensured in the working tube. At the gas outlet the hydrogen is burnt off in an exhaust gas torch. Equipped with a safety PLC control system, pre-purging, hydrogen inlet, operation, fault monitoring and purging at the end of the process are carried out automatically (with at least five times the volume of the tube). If a malfunction occurs, the tube is immediately purged with nitrogen and the system is automatically switched to a safe status.



Example of a torch

Standard Equipment

- Available for R, RHTC, RHTH, RHTV, RSH, RSV, RSRB and RSRC tube furnaces
- Gas panel for hydrogen and nitrogen
- Automatic segment-related switching on/off by a magnetic valve
- Control via safety PLC control system with touch panel
- Exhaust gas torch with temperature monitoring
- Over-temperature limiter with digital display as over-temperature protection for the furnace and charge
- Excess pressure monitoring
- Emergency purge container for nitrogen



Furnace-unrelated measuring device for a pressure range of 10^{-3} mbar or 10^{-9} mbar

Additional Equipment

- Additional gas panels for further non-flammable gases
- Operation with other flammable gases
- Gassing via program-related controllable mass flow controllers
- Bottle pressure reducer for use with bottled gas
- Air-water heat exchanger for closed loop water circuit (apart from RSRB and RSRC)

Assignment of Gas Supply Systems to Furnace Models

| Model | Gas supply system | | | | | | | |
|-------|-------------------|----|---|----|----|---|---|--|
| | 1 | 15 | 2 | 25 | 26 | 3 | 4 | |
| RD | ● | | | | | | | |
| R | ● | ● | ● | | | ● | ● | |
| RT | ● | | | | | | | |
| RHTC | ● | | ● | | | ● | ● | |
| RHTH | | | ● | | | ● | ● | |
| RHTV | | | ● | | | ● | ● | |
| RSH | ● | ● | ● | | | ● | ● | |
| RSV | ● | ● | ● | | | ● | ● | |
| RSRB | | | | | ● | ● | ● | |
| RSRC | | | | | | ● | ● | |



Single-stage rotary vane pump



Two-stage rotary vane pump



Turbomolecular pump with upstream pump

Vacuum Package

The vacuum package enables the working tube to be evacuated for vacuum operation in tube furnaces. It consists of an intermediate component for the gas outlet, a ball valve, a pressure gauge and a manually operated vacuum pump that is connected to the gas outlet by a corrugated stainless steel hose. A gas-tight furnace system is required for the use of a vacuum package, e.g. with the gas-supply packages 15, 2, 25 or 26. To protect the vacuum pump, only cold stage evacuation is allowed. The pump can then remain switched during the running program. The maximum ultimate pressure in the working tube depends on the type of pump.

- Single-stage rotary vane pump for an achievable ultimate pressure of approx. 20 mbar
- Two-stage rotary vane pump for an achievable ultimate pressure of approx. 5×10^{-2} mbar
- Turbomolecular pump system, consisting of a diaphragm pump with downstream turbomolecular pump for an achievable ultimate pressure of up to approx. 5×10^{-5} mbar (not for models RSRB and RSRC and not in combination with gas supply package 15)

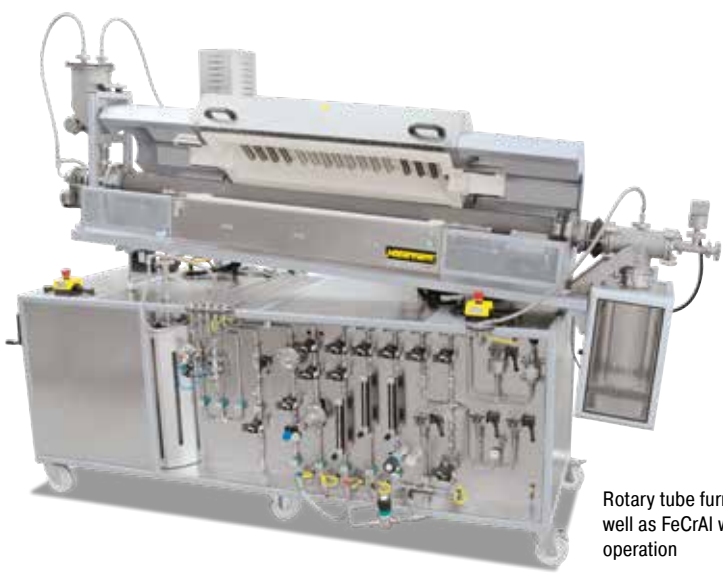

Rotary tube furnace RSRC 120/1000/11 H₂ with three-zone control, charge control as well as FeCrAl working tube, feeding system and gas supply system 4 for hydrogen operation

Controls for Tube Furnaces

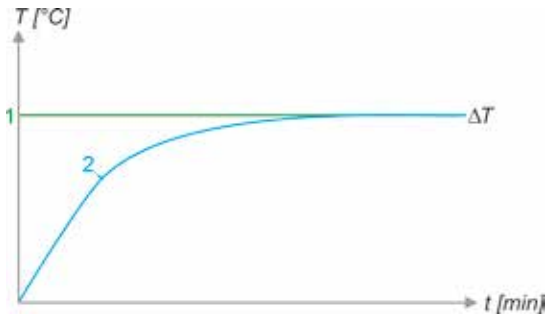

Furnace control

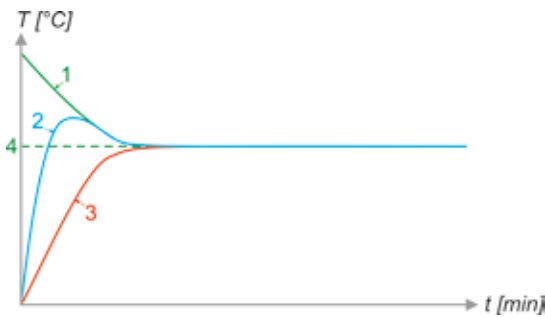

Charge control

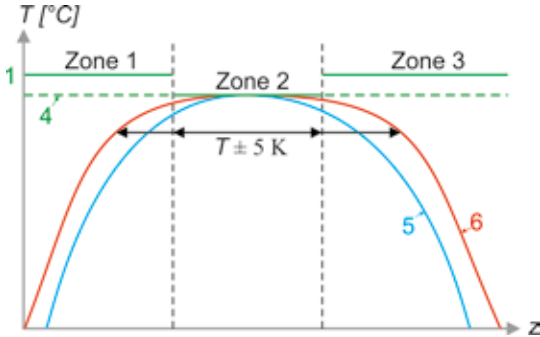

Three-Zone Furnace Chamber Control

1. Set value furnace chamber
2. Actual value furnace chamber
3. Actual value charge
4. Set value charge
5. Actual value furnace chamber single zone
6. Actual value furnace chamber three zone

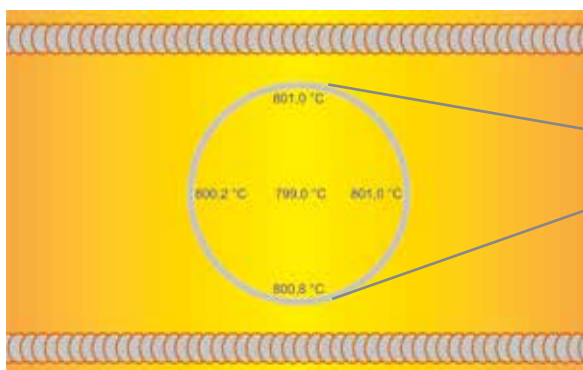

Temperature uniformity, measured in tube furnace RSH 170/750/13

Furnace Chamber and Charge Controls

With the furnace chamber control, the temperature is only measured in the furnace chamber outside the working tube. This protects the thermocouples from damage and aggressive batch. The control is slow to avoid overshoots. Since the temperature inside the working tube is not measured in this mode, a significant temperature difference can occur between the batch temperature inside the tube and the furnace chamber temperature displayed in the controller.

With an additional charge thermocouple, the "charge control" mode can measure the temperature in the furnace as well as the temperature inside the working tube. This enables the batch temperature to be controlled very precisely and quickly. Charge control can be used with all tube furnaces, with the exception of the RD and RT series.

Three-Zone Furnace Chamber Controls

The heated length is divided into three heating zones. The temperature is measured via one thermocouple per zone, which is positioned outside the working tube between the heating wires. The side zones are controlled via a setpoint offset in relation to the middle zone. In this way, the heat loss at the tube ends can be compensated in order to achieve an extended zone of constant temperature (± 5 K).

Freely Radiating Heating Elements

A very good temperature uniformity is achieved with the freely radiating heating elements on support tubes.



Customized Tube Furnaces



Tube furnace RS 200/4500/08 with lift door for heat treatment of bars



RHTV 120/600/17 H₂ with gas supply system 4 for flammable gases, swiveling hook for hanging the batch and safety door in front of the lower flange



Hinged flange

With their high level of flexibility and innovation, Nabertherm offers the optimal solution for customer-specific applications. Based on our standard models, we develop individual solutions also for integration in overriding process systems. The solutions shown on this page are just a few examples of delivered furnaces. From processes working under vacuum or protective gas via innovative control and automation technology for a wide selection of temperatures, sizes, lengths and other properties of tube furnace systems – we will find the appropriate solution for a suitable process optimization.



RSH 320/2000/09 H₂ with three-zone control for heat treatment of precious metals



RS 120/1000/11S with bogie for different inclination angles

Furnaces for Special Applications



Dual shell housing made of textured stainless steel sheets with additional fan cooling for low surface temperature



Exclusive use of insulation materials without categorization according to EC Regulation No 1272/2008 (CLP). This explicitly means that aluminosilicate wool, also known as “refractory ceramic fiber” (RCF), which is classified and possibly carcinogenic, is not used.



NTLog Basic for Nabertherm controller: recording of process data with USB-flash drive



Defined application within the constraints of the operating instructions



As additional equipment: Process control and documentation via VCD software package for monitoring, documentation and control



| Furnace Group | Model | Page |
|---|----------|------|
| Fire assay/cupellation furnaces up to 1300 °C | N ../CUP | 66 |
| Gradient or lab strand annealing furnaces up to 1300 °C | GR | 68 |
| Fast-firing furnaces up to 1300 °C | LS | 69 |
| Laboratory melting furnaces up to 1400 °C | K, KC | 70 |

Fire Assay/Cupellation Furnaces up to 1300 °C

Cupellation is a process to separate precious metals, such as gold or silver, from alloys with base metals. During the process, aggressive gases that attack the insulation and the heating are released. Cupellation furnaces N .. /13 CUP are especially designed for the very demanding process requirements.

The furnace chamber consists of a ceramic muffle, which offers very good protection for the heating elements and insulation against the vapors. A special fresh-air and exhaust air system guides exhaust gases directly into the exhaust hood of the cupellation furnace. At the same time, fresh air is lead into the furnace atmosphere. The integrated exhaust hood on top of the furnace and above the door is the interface to the customer's required exhaust air system. The design is very-maintenance friendly; all wear and tear parts on the furnace, which are f.i. the ceramic muffle and the heating elements, can be replaced easily.

Cupellation furnaces N 4/13 CUP as a tabletop model and N 10/13 CUP are designed especially for cupellation. Due of its high chamber design, model N 30/13 CUP can also be used for crucible melting. Pit-type furnace S 73/HS is especially designed for crucible melting.



Cupellation furnace N 4/13 CUP as a tabletop model

Standard Equipment of Cupellation Furnace N 4/13 CUP

- Compact tabletop model
- Ceramic muffle to protect the heating elements and insulation
- Furnace chamber is heated from three sides (floor and sides) with heating elements on support tubes
- Extraction system with integrated exhaust hood on top of the furnace and above the door to connect to the customer's exhaust air system
- Manual lift door

Additional Equipment for Cupellation Furnace N 4/13 CUP

- Over-temperature limiter with adjustable cutout temperature as temperature limiter to protect the oven and load

Standard Equipment of Cupellation Furnaces N 10/13 CUP and N 30/13 CUP

- Ceramic muffle to protect the heating elements and insulation
- Furnace chamber is heated from 4 sides with heating elements on support tubes
- The heating elements can be easily replaced as one unit
- Furnace chamber ventilated as additional protection for the heating elements
- Precise temperature control with control thermocouple directly in the muffle
- Closing brick for the muffle with handle for N 10/13 CUP
- Electro-mechanic lift door for N 30/13 CUP
- Bench/surface in front of muffle
- Special fresh-air and exhaust air system for the ceramic muffle. Exhaust gases are directly guided into the exhaust hood via a ceramic tube at the back of the muffle. The air exchange rate is adjustable.
- Extraction system with integrated exhaust hood on top of the furnace and above the door to connect to the customer's exhaust air system
- Over-temperature limiter with adjustable cutout temperature as temperature limiter to protect the oven and load



Cupellation furnace N 10/13 CUP with closing brick and base on castors

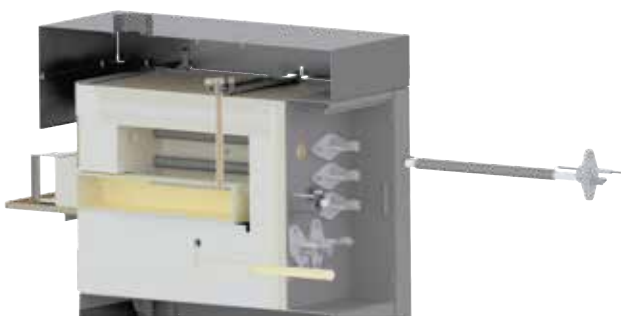

Compact heating element, easy to replace (cupellation furnaces N 10/13 CUP and N 30/13 CUP)

Additional Equipment for Cupellation Furnaces N 10/13 CUP and N 30/13 CUP

- Electro-mechanic lift door for N 10/13 CUP
- Electric lift door
- Swiveling inspection window as heat protection
- Timer to program switching on and off times (preset temperature)
- Base mounted on castors



Pit-type furnace S 73/HS with split lid

Standard Equipment of Pit-Type Furnace S 73/HS

- Compact pit-type furnace for crucible melting
- Split lid, opened manually by swiveling
- Heating from four sides
- Heating elements and floor protected against friction and aggressive substances with silicon carbide tiles
- Furnace chamber ventilated as additional protection for the heating elements
- Exhaust air box with insulated tube to the rear. Facilities for connection to customer's necessary extraction system.

Additional Equipment for Pit-Type Furnace S 73/HS

- Manual rolling lid
- Pneumatic rolling lid
- Over-temperature limiter with adjustable cutout temperature as temperature limiter to protect the oven and load
- Timer to program switching on and off times (preset temperature)

| Model | Tmax °C | Inner dimensions in mm | | | Volume in l | Outer dimensions ¹ in mm | | | Connected load kW | Electrical connection* | Weight in kg |
|-------------|------------|------------------------|-----|-----|----------------|-------------------------------------|------|------|----------------------|---------------------------|-----------------|
| | | w | d | h | | W | D | H | | | |
| N 4/13 CUP | 1280 | 185 | 250 | 80 | 3.7 | 800 | 750 | 750 | 3 | 1-phase | 105 |
| N 10/13 CUP | 1300 | 250 | 540 | 95 | 8.0 | 800 | 1300 | 1850 | 15 | 3-phase | 450 |
| N 30/13 CUP | 1300 | 250 | 500 | 250 | 25.0 | 1050 | 1300 | 2150 | 15 | 3-phase | 480 |
| S 73/HS | 1300 | 530 | 380 | 360 | 73.0 | 1050 | 1530 | 900 | 26 | 3-phase | 890 |

¹External dimensions vary when furnace is equipped with additional equipment. Dimensions on request.

*Please see page 75 for more information about supply voltage



Pit-type furnace S 73/HS with rolling lid



Sides and floor lined with silicon carbide tiles as protection for pit-type furnace S 73/HS



Ceramic muffle to protect the heating elements and insulation

Gradient or Lab Strand Annealing Furnaces up to 1300 °C

The furnace chamber of the gradient furnace GR 1300/13 is divided in six control zones of equal length. The temperature in each of the six heating zones is separately controlled. The gradient furnace is usually charged from the side through the parallel swivel door. A maximum temperature gradient of 400 °C can then be stabilized over the heated length of 1300 mm. On request the furnace also is designed as a lab strand annealing furnace with a second door on the opposite side. If the included fiber separator are used charging is carried-out from the top.



Gradient furnace GR 1300/13S

Standard Equipment

- Tmax 1300 °C
- Heated length: 1300 mm
- Heating elements on support tubes providing for free heat radiation in the kiln chamber
- Charging from the top or through the right side door
- Gas damper suspension of the lid
- Separate control of heating zones (each 160 mm long)
- Temperature gradient of 400 °C over the entire length of the kiln chamber, each zone can individually be controlled
- Fiber separators dividing the chamber in six equally sized chambers
- Controller H1700, alternative controllers see page 78

Additional Equipment

- Up to ten control zones
- Second parallel swing door for use as lab strand annealing furnace
- Vertical instead of horizontal strand furnace
- 1400 °C model

| Model | Tmax °C | Inner dimensions in mm | | | Outer dimensions ¹ in mm | | | Connected load kW | Electrical connection* | Weight in kg |
|------------|------------|------------------------|-----|----|-------------------------------------|-----|------|----------------------|---------------------------|-----------------|
| | | w | d | h | W | D | H | | | |
| GR 1300/13 | 1300 | 1300 | 100 | 60 | 1660 | 740 | 1345 | 18 | 3-phase | 300 |

¹External dimensions vary when furnace is equipped with additional equipment. Dimensions on request.

*Please see page 75 for more information about supply voltage



Parallel front swing door



Gradient furnace GR 1300/13S



Furnace chamber of gradient furnace GR 1300/13 with second door as additional equipment

Fast-Firing Furnaces up to 1300 °C

These fast-firing furnaces are ideal for simulation of typical fast-firing processes up to a maximum firing temperature of 1300 °C. The combination of high performance, low thermal mass and powerful cooling fans provides for cycle times from cold to cold up to 35 minutes with an opening temperature of approx. 300 °C.



Fast-firing furnace LS 25/13

Standard Equipment

- Tmax 1300 °C
- Ceramic grid tubes as charge support
- Floor and lid heating, two-zone control
- Special arrangement of the heating elements for optimum temperature uniformity
- Rapid switching cycles result in precise temperature control
- Integrated cooling fans, programmable to speed up charge cooling including housing cooling
- Programmable lid opening of approximately 60 mm for faster cooling without activating the fan
- Thermocouple type S for top and bottom zone
- Castors for easy furnace moving
- Controller P570 (50 programs with each 40 segments), alternative controllers see page 78

| Model | Tmax °C | Inner dimensions in mm | | | Volume in l | Outer dimensions ² in mm | | | Connected load kW | Electrical connection* | Weight in kg |
|----------|------------|------------------------|-----|-----|----------------|-------------------------------------|------|------|----------------------|---------------------------|-----------------|
| | | w | d | h | | W | D | H | | | |
| LS 12/13 | 1300 | 350 | 350 | 40 | 12 | 750 | 880 | 1090 | 15 | 3-phase ¹ | 150 |
| LS 25/13 | 1300 | 500 | 500 | 100 | 25 | 900 | 1030 | 1150 | 22 | 3-phase ¹ | 160 |

¹Heating only between two phases

²External dimensions vary when furnace is equipped with additional equipment. Dimensions on request.

*Please see page 75 for more information about supply voltage



Fast-firing furnace LS 25/13

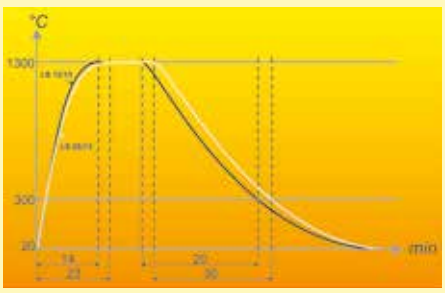

Firing curves of fast-firing furnaces LS 12/13 and LS 25/13



Floor and lid heating, two-zone control

Laboratory Melting Furnaces up to 1400 °C

These compact melting furnaces for the melting of non-ferrous metals and alloys are one of a kind and have a number of technical advantages. Designed as tabletop models, they can be used for many laboratory applications. The practical counter balanced hinge with shock absorbers and the spout (not for KC 4/14) on the front of the furnace make exact dosing easy when pouring the melt. The melting furnaces are available for furnace chamber temperatures of 1000 °C, 1300 °C, or 1400 °C.



Melting furnace KC 4/14

Standard Equipment

- Tmax 1000 °C, 1300 °C, or 1400 °C
- Crucible sizes of 0.75, 1.5 or 3 liters
- Crucible with integrated pouring spout of clay-graphite included with delivery
- Additional spout (not for KC 4/14), mounted at the furnace for exact pouring
- Compact bench-top design, simple emptying of crucible by tilting system with gas damper
- Crucible for heating up of melting furnace insulated with a hinged lid, lid opened when pouring
- Controller R7 (resp. 3508 for KC), alternative controllers see page 78

Additional Equipment

- Other crucible types available, e.g. steel
- Design as bale-out furnace without tilting device, e.g. for lead melting
- Over-temperature limiter for the furnace chamber with automatic reset to protect against overtemperature. The limit controller switches off the heating when the pre-set limit temperature has been reached and does not switch it on again until the temperature falls below the setting again.
- Observation hole for melt

| Model | Tmax furnace °C | Tmax melt bath °C | Crucible | Capacity in kg | | Volume in l | Outer dimensions ³ in mm | | | Connected load kW | Weight in kg |
|----------------------|--------------------|----------------------|----------|-------------------|----|----------------|-------------------------------------|-----|-----|----------------------|-----------------|
| | | | | Al | Cu | | W | D | H | | |
| K 1/10 | 1000 | 850 | A6 | 1,5 | - | 0.75 | 600 | 710 | 670 | 3.0 | 85 |
| K 2/10 | 1000 | 850 | A10 | 3 | - | 1.50 | 600 | 710 | 670 | 3.0 | 90 |
| K 4/10 | 1000 | 850 | A25 | 7 | - | 3.00 | 670 | 800 | 710 | 3.5 | 110 |
| K 1/13 ¹ | 1300 | 1150 | A6 | 1,5 | 6 | 0.75 | 600 | 710 | 670 | 3.0 | 85 |
| K 2/13 ¹ | 1300 | 1150 | A10 | 3 | 10 | 1.50 | 600 | 710 | 670 | 3.0 | 90 |
| K 4/13 ¹ | 1300 | 1150 | A25 | 7 | 25 | 3.00 | 670 | 800 | 710 | 5.5 | 110 |
| KC 1/14 ² | 1400 | 1250 | A6 | - | 6 | 0.75 | 570 | 630 | 580 | 11.0 | 90 |
| KC 2/14 ² | 1400 | 1250 | A10 | - | 10 | 1.50 | 570 | 630 | 580 | 11.0 | 95 |
| KC 4/14 ² | 1400 | 1250 | A25 | - | 25 | 3.00 | 670 | 870 | 590 | 22.0 | 110 |

¹Outer dimensions of furnace, transformer in separate housing (500 x 570 x 300 mm)

²Switchgear and controller mounted in a floor standing cabinet

³External dimensions vary when furnace is equipped with additional equipment. Dimensions on request.



Tilting-aid with dampers



Furnace K 4/10 with steel crucible, e.g. for tin melting



Melting furnace KC 1/14

Temperature Uniformity and System Accuracy



Holding frame for measurement of temperature uniformity

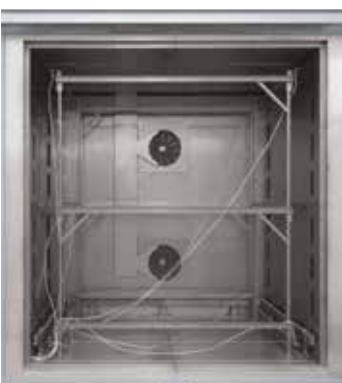

Pluggable frame for measurement for forced convection chamber furnace N 7920/45 HAS

Temperature uniformity is defined as the maximum temperature deviation in the work space of the furnace. There is a general difference between the furnace chamber and the work space. The furnace chamber is the total volume available in the furnace. The work space is smaller than the furnace chamber and describes the volume which can be used for charging.

Specification of Temperature Uniformity in +/- K in the Standard Furnace

In the standard design the temperature uniformity is specified in +/- K at a defined set-temperature with the work space of the empty furnace during the dwell time. In order to make a temperature uniformity survey the furnace should be calibrated accordingly. As standard our furnaces are not calibrated upon delivery.

Calibration of the Temperature Uniformity in +/- K

If an absolute temperature uniformity at a reference temperature or at a defined reference temperature range is required, the furnace must be calibrated appropriately. If, for example, a temperature uniformity of +/- 5 K at a set temperature of 750 °C is required, it means that measured temperatures may range from a minimum of 745 °C to a maximum of 755 °C in the empty work space.

System Accuracy

Tolerances may occur not only in the work space, they also exist with respect to the thermocouple and in the controls. If an absolute temperature uniformity in +/- K at a defined set temperature or within a defined reference working temperature range is required, the following measures have to be taken:

- Measurement of total temperature deviation of the measurement line from the controls to the thermocouple
- Measurement of temperature uniformity within the work space at the reference temperature or within the reference temperature range
- If necessary, an offset is set at the controls to adjust the displayed temperature at the controller to the real temperature in the furnace
- Documentation of the measurement results in a protocol

Temperature Uniformity in the Work Space incl. Protocol

In standard furnaces, temperature uniformity is guaranteed as +/- K without measurement of temperature uniformity. However, as an additional feature, a temperature uniformity measurement at a target temperature in the work space compliant with DIN 17052-1 can be ordered. Depending on the furnace model, a holding frame which is equivalent in size to the work space is inserted into the furnace. This frame holds thermocouples at up to 11 defined measurement positions. The measurement of the temperature uniformity is performed at a target temperature specified by the customer after a static condition has been reached. If necessary, different target temperatures or a defined target working temperature range can also be calibrated.



The system accuracy is defined by adding the tolerances of the controls, the thermocouple and the work space

Precision of the controls, e.g. +/- 1 K

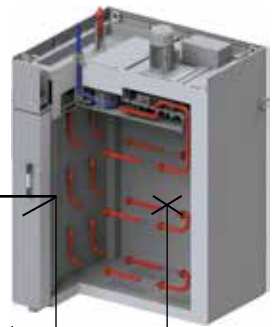

Deviation of thermocouple, e.g. +/- 1.5 K

Deviation from measuring point to the average temperature in the work space e.g. +/- 3 K

Process Control and Documentation





| | Page |
|--|------|
| Nabertherm Controller Series 500 | 74 |
| MyNabertherm App for Mobile Monitoring of Process Progress | 76 |
| Functions of the standard controllers | 78 |
| Process Data Storage and Data Input via PC | 79 |
| PLC Controls - HiProSystems | 81 |
| Process Data Storage | 82 |
| Nabertherm Control Center NCC | 83 |

Nabertherm Controller Series 500

**I AM THE
CONTROLLER**

I'm the big brother of analog buttons and turning switches. I am the new generation of control and intuitive operation. My skills are highly complex, my operation is simple. I can be touched and speak 24 languages. I'll show you exactly which program is currently running and when it ends.



The controller series 500 impresses with its unique scope of performance and intuitive operation. In combination with the free "MyNabertherm" smartphone app, the operation and monitoring of the furnace is even easier and more powerful than ever before. The operation and programming takes place via a high-contrast, large touch panel, which shows exactly the information that is relevant at the moment.



Standard Equipment

- Transparent, graphic display of the temperature curves
- Clear presentation of the process data
- 24 operating languages selectable
- Consistent, attractive design
- Easily understandable symbols for many functions
- Precise and accurate temperature control
- User levels
- Program status display with estimated end time and date
- Documentation of the process curves on USB storage medium in .csv file format
- Service information can be read out via USB stick
- Clear presentation
- Plain text display
- Configurable for all furnace families
- Can be parameterized for the different processes



Highlights

In addition to the well-known and matured controller functions, the new generation offers you some individual highlights. Here is an overview of the most important ones for you:

Modern Design



Colored display of temperature curves and process data

Easy Programming



Simple and intuitive program entry via touch panel

Integrated Help Function



Information on various commands in plain text

Program Management



Temperature programs can be saved as favorites and in categories

Segment Player



Detailed overview of process information including setpoint, actual value and switched functions

Wi-Fi-Capable



Connection with the MyNabertherm app



Intuitive touch screen



Easy program entry and control



Precise temperature control



User levels



Process documentation on USB

Further information on Nabertherm controllers, process documentation and tutorials on operation can be found on our website: <https://nabertherm.com/en/series-500>



MyNabertherm App for Mobile Monitoring of Process Progress

MyNabertherm app – the powerful and free digital accessory for Nabertherm 500 Series Controllers. Use the app for convenient online progress monitoring of your Nabertherm furnaces – from your office, while on the way or from wherever you wish. The app always keeps you in the picture. Just like the controller itself, the app is also available in 24 languages.



Convenient monitoring of one or multiple Nabertherm furnaces simultaneously

App-Functions

- Convenient monitoring of one or multiple Nabertherm furnaces simultaneously
- Clear presentation as a dashboard
- Individual overview of a furnace
- Display of active/inactive furnaces
- Operating status
- Current process data

Display of Program Progress for Each Furnace

- Graphical representation of the program progress
- Display of furnace name, program name, segment information
- Display of start time, program run time, remaining run time
- Display of additional functions such as fresh-air fan, exhaust air flap, gassing, etc.
- Operating modes as symbol



Display of program progress for each furnace

Push Notifications in Case of Malfunctions and at Program End

- Push notification on the lock screen
- Display of malfunctions with an associated description in the individual overview and in a message list

Contact with Service Possible

- Stored furnace data facilitate rapid support for you

Requirements

- Connection of the furnace to the Internet via the customer's Wi-Fi
- For mobile devices with Android (from version 9) or IOS (from version 13)



Easy to contact



Monitoring of Nabertherm furnaces with 500 series touch panel controller for Arts & Crafts, laboratory, dental, thermal process technology, advanced materials and foundry applications.

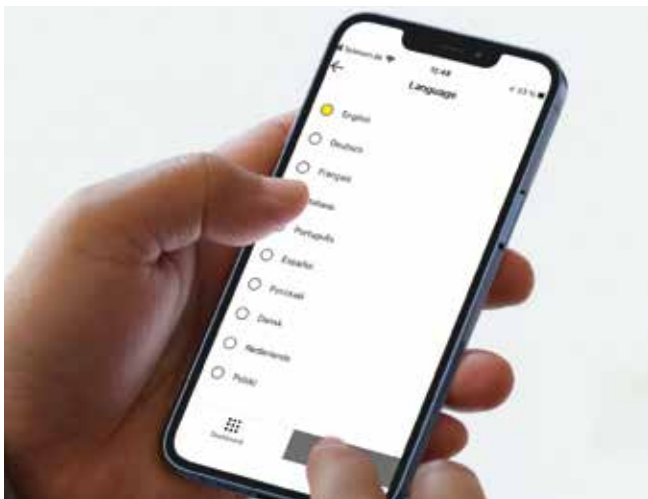

Available in 24 languages



Push notifications in case of malfunctions



Clear contextual menu



Any addition of Nabertherm furnaces

Everything on display in the new Nabertherm app for the new controller series 500. Get the most out of your furnace with our app for iOS and Android. Don't hesitate to download it now.



Functions of the Standard Controllers

| | R7 | 3216 | 3208 | B500/ B510 | C540/ C550 | P570/ P580 | 3508 | 3504 | H500 | H1700 | H3700 | NCC |
|---|----|------|------|---------------|---------------|---------------|-----------------------------|-----------------------------|------------------|------------------|------------------|-------------------|
| Number of programs | 1 | 1 | | 5 | 10 | 50 | 1/10/ 25/50 ³ | 1/10/ 25/50 ³ | 20 | 20 | 20 | 100 |
| Segments | 1 | 8 | | 4 | 20 | 40 | 500 ³ | 500 ³ | 20 | 20 | 20 | 20 |
| Extra functions (e. g. fan or autom. flaps) maximum | | | | 2 | 2 | 2-6 | 0-4 ³ | 2-8 ³ | 3 ³ | 6/2 ³ | 8/2 ³ | 16/4 ³ |
| Maximum number of control zones | 1 | 1 | 1 | 1 | 1 | 3 | 2 ^{1,2} | 2 ^{1,2} | 1-3 ³ | 8 | 8 | 8 |
| Drive of manual zone regulation | | | | ● | ● | ● | | | ○ | ○ | ○ | ○ |
| Charge control/bath control | | | | | | | ○ | ○ | ○ | ○ | ○ | ○ |
| Auto tune | | ● | ● | ● | ● | ● | ● | ● | | | | |
| Real-time clock | | | | ● | ● | ● | | | ● | ● | ● | ● |
| Graphic color display | | | | ● | ● | ● | | | 4" 7" | 7" | 12" | 22" |
| Graphic display of temperature curves (program sequence) | | | | | | | | | | | | |
| Status messages in clear text | | | ● | ● | ● | ● | ● | ● | ● | ● | ● | ● |
| Data entry via touchpanel | | | | ● | ● | ● | | | ● | ● | ● | ● |
| Entering program names (i.e. "Sintering") | | | | ● | ● | ● | | | ● | ● | ● | ● |
| Keypad lock | | | | ● | ● | ● | ○ | ○ | | | | |
| User levels | | | | ● | ● | ● | ● | ● | ○ | ○ | ○ | ● |
| Skip-button for segment jump | | | | ● | ● | ● | | | ● | ● | ● | ● |
| Program entry in steps of 1 °C or 1 min. | ● | ● | ● | ● | ● | ● | ● | ● | ● | ● | ● | ● |
| Start time configurable (e. g. to use night power rates) | | | | ● | ● | ● | ● | ● | ● | ● | ● | ● |
| Switch-over °C/°F | ○ | ○ | ○ | ● | ● | ● | ○ | ○ | ● | ● ³ | ● ³ | ● ³ |
| kWh meter | | | | ● | ● | ● | | | | | | |
| Operating hour counter | | | | ● | ● | ● | | | ● | ● | ● | ● |
| Set point output | | | ○ | ● | ● | ● | ○ | ○ | | ○ | ○ | ○ |
| NTLog Comfort for HiProSystems: recording of process data on an external storage medium | | | | | | | | | ○ | ○ | ○ | |
| NTLog Basic for Nabertherm controller: recording of process data with USB-flash drive | | | | ● | ● | ● | | | | | | |
| Interface for VCD software | | | | ○ | ○ | ○ | ○ | ○ | | | | |
| Malfunction memory | | | | ● | ● | ● | | | ● | ● | ● | ● |
| Number of selectable languages | | | | 24 | 24 | 24 | | | | | | |
| Wi-Fi-capable („MyNabertherm" app) | | | | ● | ● | ● | | | | | | |

¹ Not for melt bath control

² Control of additional separate slave regulators possible

³ Depending on the design

● Standard

○ Option

| Which controller for which furnaces | TR | TR .. LS | KTR | NAT 15/65 | NA 30/45 - NA 675/85 | L 1/12 | L 3 - LT 40 | LE | L(T) 9/11/SKM | LV(T) | L .. /11 BO | L(T) 9 / .. /SW | LH, LF | N .. /H | LHTC(T) | LHT .. /.. (D) | LHT .. /17 LB Speed, LHT 16/17 LB | LHT 04/.. SW | HT, HFL | HTC | RD | R | RSH/RSV | RSRB, RSRC | RT | RHTC | RHTH/RHTV | N .. CUP | GR | LS | K | KC | |
|-------------------------------------|----|----------|-----|-----------|----------------------|--------|-------------|----|---------------|-------|-------------|-----------------|--------|---------|---------|----------------|-----------------------------------|--------------|----------------|----------------|----|----|---------|------------|----|------|-----------|----------|----|----|----|----------------|---|
| Catalog page | 6 | 6 | 8 | 10 | 10 | 14 | 14,17,18 | 16 | 19 | 20 | 22 | 23 | 28 | 30 | 34 | 35 | 36 | 37 | 38,41 | 39 | 44 | 45 | 46 | 48 | 52 | 53 | 54 | 66 | 68 | 69 | 70 | 70 | |
| Controller | | | | | | | | | | | | | | | | | | | | | | | | | | | | | | | | | |
| R7 | ● | | | | | ● | | ● | | | | | | | | | | | | | ● | | | | | | | | | | | ● | |
| 3508 | | | | | | | | | | | | | | | | | | | | | | | | | | | | | | | | | ● |
| B500 | | | ● | | ● | | | | | | | | ● | ● | | | | | | | | | | ● | | | | ● | | | | | |
| B510 | ○ | | | ● | | | ● | | ● | ● | | ● | | | | | | | | | | | ● | ● | ● | ● | | | | | | | |
| C540 | | ○ | ○ | | ○ | | | | | | | | ○ | ○ | | | | | | | | | ○ | ○ | ○ | ○ | | | | | | | |
| C550 | ○ | ● | | ○ | | | ○ | | ○ | ○ | ● | ○ | | | ● | | | | | | | | ○ | ○ | ○ | ○ | | | | | | | |
| P570 | | | ○ | | ○ | | | | | | | | ○ | ○ | | ● | ● | ● | ● ³ | ● ³ | | | | ○ | ○ | | ● | | | | | ● ³ | |
| P580 | ○ | | | ○ | | | ○ | | ○ | ○ | ○ | ○ | | | ○ | | | | | | | | ○ | ○ | ○ | ○ | | | | | | | |
| H500/PLC | | | | | ○ | | | | | | | | ○ | | | | | | | | | | ○ | ○ | | | ○ | | | | | | |
| H1700/PLC | | | ○ | | ○ | | | | | | | | | | | | | | | | | | ○ | ○ | | | | ● | | | | | |
| H3700/PLC | | | ○ | | ○ | | | | | | | | | | | | | | | | | | ○ | ○ | | | | ○ | | | | | |
| NCC | | | ○ | | ○ | | | | | | | | ○ | | | | | | | | | | ○ | ○ | | ○ | | | | | | | |

Mains Voltages for Nabertherm Furnaces

1-phase: all furnaces are available for mains voltages from 110 V - 240 V at 50 or 60 Hz.

3-phase: all furnaces are available for mains voltages from 200 V - 240 V or 380 V - 480 V, at 50 or 60 Hz.

The connecting rates in the catalog refer to the standard furnace with 400 V (3/N/PE) respectively 230 V (1/N/PE).

Process Data Storage and Data Input via PC



There are various options for evaluation and data input the processes for optimal process documentation and data storage. The following options are suitable for data storage when using the standard controllers.

Data Storing of Nabertherm Controllers with NTLog Basic

NTLog Basic allows for recording of process data of the connected Nabertherm Controller (B500, B510, C540, C550, P570, P580) on a USB stick. The process documentation with NTLog Basic requires no additional thermocouples or sensors. Only data recorded which are available in the controller. The data stored on the USB stick (up to 130,000 data records, format CSV) can afterwards be evaluated on the PC either via NTGraph or a spreadsheet software used by the customer (e.g. Excel™ for MS Windows™). For protection against accidental data manipulation the generated data records contain checksums.

Visualization with NTGraph for MS Windows™ for Single-Zone Controlled Furnaces

The process data from NTLog can be visualized either using the customer's own spreadsheet program (e.g. Excel™ for MS Windows™) or NTGraph for MS Windows™ (Freeware). With NTGraph Nabertherm provides for an additional user-friendly tool free of charge for the visualization of the data generated by NTLog. Prerequisite for its use is the installation of the program Excel™ for MS Windows™ (from version 2003). After data import presentation as diagram, table or report can be chosen. The design (color, scaling, reference labels) can be adapted by using prepared sets. NTGraph is available in eight languages (DE/EN/FR/ES/IT/CN/RU/PT). In addition, selected texts can be generated in other languages.

Software NTEdit for MS Windows™ for Entering Programs on the PC

By using the software NTEdit for MS Windows™ (Freeware) the input of the programs becomes clearer and thus easier. The program can be entered on customers PC and then be imported into the controller (B500, B510, C540, C550, P570, P580) with a USB stick. The display of the set curve is tabular or graphical. The program import in NTEdit is also possible. With NTEdit Nabertherm provides a user-friendly free tool. A prerequisite for the use is the client installation of Excel™ for MS Windows™ (from version 2007). NTEdit is available in eight languages (DE/EN/FR/ES/IT/CN/RU/PT).



NTGraph, a freeware for the easy-to-read analysis of recorded data using Excel™ for MS Windows™



Recording of process data of the connected controller via USB stick



Process input via the NTEdit software (freeware) for MS Windows™

Process Data Storage

VCD-software for visualization, control and documentation

Documentation and reproducibility are more and more important for quality assurance. The powerful VCD software represents an optimal solution for single multi furnace systems as well as charge documentation on the basis of Nabertherm controllers.

The VCD software is used to record process data of the series 500 and series 400 as well as various further Nabertherm controllers. Up to 400 different heat treatment programs can be stored. The controllers are started and stopped via the software at a PC. The process is documented and archived accordingly. The data display can be carried-out in a diagram or as data table. Even a transfer of process data to Excel™ for MS Windows™ (.csv format *) or the generation of reports in PDF format is possible.



Example lay-out with 3 furnaces

Features

- Available for controllers series 500 - B500/B510/C540/C550/P570/P580, series 400 - B400/B410/C440/C450/P470/P480, Eurotherm 3504 and various further Nabertherm controllers
- Suitable for operating systems Microsoft Windows 7/8/10/11
- Simple installation
- Setting, Archiving and print of programs and graphics
- Operation of controllers via PC
- Archiving of process curves from up to 16 furnaces (also multi-zone controlled)
- Redundant saving of archives on a server drive
- Higher security level due to binary data storage
- Free input of charge date with comfortable search function
- Possibility to evaluate data, files exportable to Excel™ for MS Windows™
- Generation of a PDF-report
- 24 languages selectable

Extension Package 1 for display of an additional temperature measuring point, independant of the furnace controls

- Connection of an independent thermocouple, type S, N or K with temperature display on a supplied C6D display, e. g. for documentation of charge temperature
- Conversion and transmission of measured values to the VCD software
- For data evaluation, please see VCD-software features
- Display of measured temperature directly on the extension package

Extension Package 2 for the connection of up to three, six or nine measuring point, independant of the furnace controls

- Connection of three thermocouples, tpye K, S, N or B to the included connecting box
- Possible extension of up to two or three connecting boxes with up to nine measuring points
- Conversion and transmission of measured values to the VCD software
- Data evaluation, see VCD features



VCD Software for Control, Visualisation and Documentation



Graphic display of main overview (version with 4 furnaces)

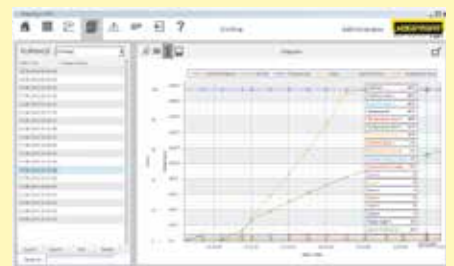

Graphic display of process curve

PLC Controls HiProSystems



This professional process control with PLC controls for single and multi-zone furnaces is based on Siemens hardware and can be adapted and upgraded extensively. HiProSystems control is used when process-dependent functions, such as exhaust air flaps, cooling fans, automatic movements, etc., have to be handled during a cycle, when furnaces with more than one zone have to be controlled, when special documentation of each batch is required and when remote service is required. It is flexible and is easily tailored to your process or documentation needs.

Alternative User Interfaces for HiProSystems

Process Control H500

This basic panel accommodates most basic needs and is very easy to use. Firing cycle data and the extra functions activated are clearly displayed in a table. Messages appear as text. Data can be stored on a USB stick using the „NTLog Comfort“ option.

Process Control H1700

Customized versions can be realized in addition to the scope of services of the H500. Display of basic data as online trend on a color 7" display with graphically structured interface.

Process Control H3700

Display of functions on a large 12" display. Display of basic data as online trend or as a graphical system overview. Scope as H1700.

Remote Maintenance Router – Fast Support in Case of a Malfunction

For fast failure diagnosis in case of a malfunction, remote maintenance systems are used for HiProSystems-plants (depending on the model). The plants are equipped with a router, which will be connected to the internet by the customer. In case of a malfunction, Nabertherm is able to get access to the furnace controls via a secured connection (VPN tunnel) and to perform a malfunction diagnosis. In most cases, the problem can be directly solved by a technician on site according with supervision from Nabertherm.

If no Internet connection can be provided, we offer optionally the remote maintenance via LTE network as additional equipment.



H1700 with colored, tabular depiction



H3700 with colored graphic presentation



Router for remote maintenance

Process Data Storage



The following options are available for industrial process documentation and the recording of data from several furnaces. These can be used to document the process data for the PLC controls.



NTLog Comfort for data recording of a Siemens PLC via USB stick

Data Storing of HiProSystems with NTLog Comfort

The extension module NTLog Comfort offers the same functionality of NTLog Basic module. Process data from a HiProSystems control are read out and stored in real time on a USB stick. The extension module NTLog Comfort can also be connected using an Ethernet connection to a computer in the same local network so that data can be written directly onto this computer.

Temperature Recorder

Besides the documentation via the software which is connected to the controls, Nabertherm offers different temperature recorders which can be used with respect to the application.

| | Model 6100e | Model 6100a | Model 6180a |
|--|-------------|-------------|-------------|
| Data input using touch panel | x | x | x |
| Size of colour display in inch | 5.5" | 5.5" | 12.1" |
| Number of thermocouple inputs | 3 | 18 | 48 |
| Data read-out via USB-stick | x | x | x |
| Input of charge data | | x | x |
| Evaluation software included | x | x | x |
| Applicable for TUS-measurements acc. to AMS2750F | | | x |

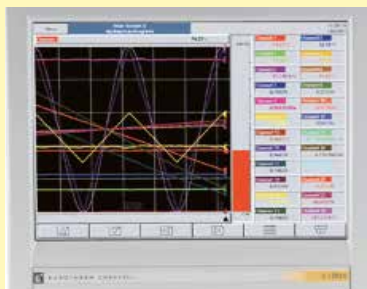

Temperature recorder

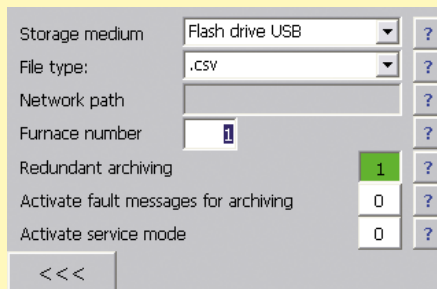

NTLog Comfort - Data recording via USB stick

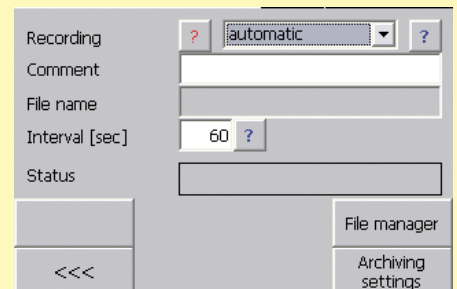

NTLog Comfort - Data recording online on the PC

Nabertherm Control Center NCC

PC-based control, process visualization and process documentation software

The Nabertherm Control Center as PC-supported furnace controls offers an ideal extension for furnaces with PLC based HiProSystem controls. The system has proven itself in many applications with increased demands on documentation and process reliability and also for convenient multi-furnace management. Many customers from the automotive, aviation, medical technology or technical ceramics sectors have been working successfully with this powerful software.



Retort furnace NR 300/08 for treatment in high vacuum

Standard Equipment

- Central furnace management
- Graphical furnace overview of up to 8 furnaces
- Tabular, clear program entry (100 program locations)
- Charge administration (article, quantity, additional information)
- Connection to the company network
- Adjustable access rights
- Online monitoring of the heat treatment
- Tamper-proof documentation
- Malfunction message list, adapted to the furnace model
- Archive function
- Delivery incl. PC and printer
- Measuring range calibration of up to 18 temperatures per measurement point. Multi-stage calibration is possible for applications with normative requirements.



Retort furnace NR 80/11 with IDB safety concept for debinding under non-flammable protective gases

Additional Equipment

- Reading in charge data via barcode
 - Simple data acquisition, ideal for frequently changing charges
 - Defined charge data ensures data quality
- Recipe storage with charge comparison
 - Comparison of charge and recipe to increase process reliability
- Adaptable access rights or access rights via employee cards
- Software extension to fulfill documentation requirements according to norms like AMS2750F (NADCAP), CQI9 or Food and Drug Administration (FDA), Part 11, EGV 1642/03
- Interface for connection to overriding systems
- SQL connection
- Redundant data storage
- Cellular connection or network connection for notification via SMS, e.g. in the event of malfunctions
- Control from different PC workstations
- Configuration as industrial PC or virtual machine
- PC cabinet
- UPS for PC
- Customization according to individual requirements



System overview

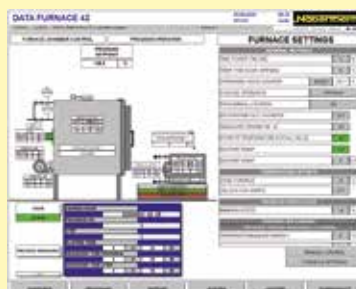

Furnace overview

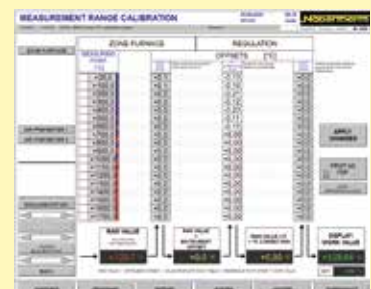

Measurement range calibration



Spare Parts and Customer Service – Our Service Makes the Difference

For many years the name **Nabertherm** has been standing for top quality and durability in furnace manufacturing. To secure this position for the future as well, Nabertherm offers not only a first-class spare parts service, but also excellent customer service for our customers. Benefit from more than 70 years of experience in furnace construction.

In addition to our highly qualified service technicians on site, our service specialists in Lilienthal are also available to answer your questions about your furnace. We take care of your service needs to keep your furnace always up and running. In addition to spare parts and repairs, maintenance and safety checks as well as temperature uniformity measurements are part of our service portfolio. Our range of services also includes the modernization of older furnace systems or new linings.

The needs of our customers always have highest priority!



- Very fast spare parts supply, many standard spare parts in stock
- Worldwide customer service on site with its own service points in the largest markets
- International service network with long-term partners
- Highly qualified customer service team for quick and reliable repair of your furnace
- Commissioning of complex furnace systems
- Customer training in function and operation of the system
- Temperature uniformity measurements, also according to standards like AMS2750F (NADCAP)
- Competent service team for fast help on the phone
- Safe teleservice for systems with PLC controls via modem, ISDN or a secured VPN line
- Preventive maintenance to ensure that your furnace is ready for use
- Modernization or relining of older furnace systems

Contact us:



contact@nabertherm.com



+49 (4298) 922-0



The whole World of Nabertherm: www.nabertherm.com

Please visit our website www.nabertherm.com and find out all you want to know about us - and especially about our products.

In addition to current information and exhibition dates, there is of course the possibility of direct contact or an authorized dealer from our worldwide dealer network.

Professional Solutions for:

- Thermal Process Technology
- Advanced Materials
- Fiber Optics/Glass
- Foundry
- Laboratory
- Dental
- Arts & Crafts

Headquarters:

Nabertherm GmbH

Bahnhofstr. 20
28865 Lilienthal, Germany
Fon +49 4298 922 0
contact@nabertherm.de

Sales Organisation

China

Nabertherm Ltd. (Shanghai)
No. 158, Lane 150, Pingbei Road, Minhang District
201109 Shanghai, China
Fon +86 21 64902960
contact@nabertherm-cn.com

France

Nabertherm SARL
20, Rue du Cap Vert
21800 Quetigny, France
Fon +33 6 08318554
contact@nabertherm.fr

Great Britain

Nabertherm Ltd., United Kingdom
Fon +44 7508 015919
contact@nabertherm.com

Italy

Nabertherm Italia
via Trento N° 17
50139 Florence, Italy
Fon +39 348 3820278
contact@nabertherm.it

Switzerland

Nabertherm Schweiz AG
Altgraben 31 Nord
4624 Härkingen, Switzerland
Fon +41 62 209 6070
contact@nabertherm.ch

Benelux

Nabertherm Benelux, The Netherlands
Fon +31 6 284 00080
contact@nabertherm.com

Spain

Nabertherm España
c/Marti i Julià, 8 Bajos 7ª
08940 Cornellà de Llobregat, Spain
Fon +34 93 4744716
contact@nabertherm.es

USA

Nabertherm Inc.
64 Reads Way
New Castle, DE 19720, USA
Fon +1 302 322 3665
contact@nabertherm.com



All other Countries: Follow

<https://www.nabertherm.com/contacts>