

ROHDE 

Enjoy your **results.**

Ceramics and Glass

ROHDE KILNS AND MACHINERY

WELCOME TO ROHDE

QUALITY

SAFETY

EFFICIENCY

PASSION

	About ROHDE	4 - 5
	Which is the right kiln?	6 - 7
ELECTRIC TOPLOADERS	Toploaders Details	8 - 11
	Toploaders Ecotop	12
	Toploaders TE-MCC+	13
	Toploaders TE-S	14
	Toploaders TE-Q und BT	15
ELECTRIC HOOD KILNS	Hood kilns HE and Overview	16 - 17
	Frontloaders Details	18 - 21
ELECTRIC FRONTLOADERS	Frontloaders KE-L	22 - 23
	Frontloaders KE-N	24
	Frontloaders KE-S	25
	Frontloaders ELS Ergo Load System	26 - 27
	Frontloaders KE-S+	28
	Frontloaders KE-SH	29
	Frontloaders Accessories and Overview	31
	Gas kilns TG and KG	32 - 35
GAS AND RAKU KILNS	Raku kilns TR and KR	36 - 37
	Fusing kilns TE-MCC+ and Fusing	38 - 41
ELECTRIC FUSING KILNS	Fusing kilns FE	42 - 43
	Kiln controllers	44 - 49
MACHINERY AND EQUIPMENT	Machinery and equipment	50 - 51
	Pottery wheel HMT 500	52
	Pugmill TS 20	53
	Slab roller PW 600	54
	Spray booth SK 66	55
	Banding wheels	56 - 57
	Sedimentation basin AB 100	58
	Standard series and special constructions	59
ANYTHING IS POSSIBLE		
SERVICE	Delivery and set-up service, warranty	60 - 61

For more than 30 years, ROHDE has been committed to customer and product benefits. This can be recognised when working with ROHDE kilns and machinery particularly when it comes to handling, efficiency, quality and results. Each day more than 100 employees make every effort to offer outstanding technology and performance. They contribute towards the best possible implementation of your creations, products and workpieces, and allow your expertise to show-off to its best advantage.

PROVEN
ROHDE SAFETY
AND QUALITY



PEOPLE LIKE YOU MOTIVATE US TO GIVE OUR BEST.

ROHDE is committed to sustainability and ecological awareness and attaches great importance to energy efficiency and product durability from choice of material to kiln operation. ROHDE's in-house production offers highest flexibility and performance from a single source. ROHDE has a network of qualified retailers serving the European market and guarantees fast supply of spare parts. The ROHDE delivery and set-up service provides safe on-site delivery of your kiln.

ROHDE supports and promotes arts and ceramics and is active participant at symposia, workshops and the Diessen Ceramic Award. ROHDE employees are highly motivated to offer you technical lead and advantages in all fields of ceramics. Benefit from smooth processes and efficient workflows when it comes to consulting, development, construction and manufacture of your kiln, as well as sales and all other services and enjoy your results.



„WE ARE COMMITTED
TO OFFERING ADVANTAGES
IN TECHNOLOGY AND QUALITY.“

Helmut and Benjamin Rohde



Benefit from the tips and information presented on these pages when choosing your new kiln and enjoy your results - right from the start.

Energy

The creative process begins with the choice of the type of energy used in your firing processes. ROHDE kilns are suitable for electrical or gas operation.

Advantages of electrically operated kilns:

- Fully automated and precise control of the firing process using intuitive controllers
- Easy and reproducible control of the firing process using storable firing programs
- Runs automatically without the need for monitoring of the firing process

Requirements: 230V ("Schuko" connector) up to 60 litres kiln volume, high-voltage current for larger models

Advantages of gas-operated kilns:

- Allows firing techniques such as reduction or raku firing
- Best possible energy efficiency for kiln volumes above 300 litres
- Know-how is important for manual control of the firing process

Requirements: propane, butane or natural gas supply



Firing temperature

Before buying a kiln, you usually know exactly what firing temperatures will be necessary for your applications. With the exception of some models, most of the ROHDE product range is suitable for maximum temperatures of 1320°C. This means you are on the safe side for almost any project.

To achieve sufficient power reserve for toploaders up to 60 litres, ROHDE recommends selection of the high-voltage variant for applications requiring more than 1200°C.



Kiln size

The kiln size is determined by the size of the ware to be fired and the firing rhythm. If you fire mainly different sizes or very small pieces, ROHDE recommends that you purchase two smaller kilns instead of just one large one. Large kilns only work economically if they are tightly loaded. However, large individual pieces require a bigger kiln. The somewhat higher initial costs for a customised construction may achieve break-even within a short period of time. When considering the details for interior dimensions, consider a buffer in space for unheated areas and heating elements.

Keep in mind the transport and movement of your kiln to its operation location and make appropriate arrangements. In addition, the kiln volume of many ROHDE Toploader models can be increased by fitting in an extension ring. This not only makes it significantly easier to transport your kiln, but also allows it to be adjusted to additional requirements later.



WHICH KILN IS
SUITABLE FOR ME?

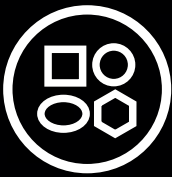

Construction

The technical opportunities allow for endless variations. Whether round, rectangular or square, whether you load from front, top or a kiln floor that is pulled out - there are no limits to design options. The choice depends on your individual conditions and requirements:

- Top loading: good overview of the firing chamber - choose a toploader
- Front loading: effective use of kiln height - choose a frontloader
- Loading from more than one side: optimal efficiency, safety and ergonomics - choose a hood kiln or the ELS Ergo-Load-System

The way the heating elements are mounted makes a difference in electrically operated kilns:

- Recessed into grooved bricks: heating elements mounted in protected position against damage
- Mounted on support rods: good heat radiation, heating elements can be easily replaced

The technically solid dimensioning of each heating element and the use of high-quality Kanthal wire are important requirements for highest performance and efficiency. When it comes to exact calculation, ROHDE considers a low surface load, a good gradient factor and the highest possible wire strength as decisive factors for durability and power reserve.

ROHDE recommends using heating elements mounted on support rods for regular applications at temperature ranges higher than 1280°C.

Accessories and equipment

Efficient accessories and additional equipment make the daily working routine easier. First consider available features and then choose according to your requirements:

- Controller: easy and intuitive to operate, detachable, safe over-temperature cut-out
- Safety: door safety switch, low external temperature, lockable kiln door
- Exhaust air: good air ventilation of the firing chamber using exhaust air and air supply slides or exhaust air socket
- Available special features: kiln floor heating, multiple-zone control, door hinge on left side instead of right, lid heating, exhaust air hood, castors, view port to monitor firing

ROHDE can always provide a simple and efficient solution for almost any special request.

Quality

The quality of a kiln is basically shown by such criteria as durability, firing results, functional safety as well as energy consumption and the necessity for spare parts. The design of ROHDE products is outstanding in all these aspects providing the highest product confidence. High-quality material and construction properties such as a V2A stainless steel jacket or a completely ventilated steel frame guarantee highest quality and corrosion protection. The top and walls are joined mortar-free and are not only attractive but allow natural thermal expansion of the kiln, preventing cracks and particles falling from the ceiling onto the ware. These are optimal prerequisites for a long service life, reliable functionality and first-class results.

Incidentally, all ROHDE kilns for ceramics and glass applications have a 3-year warranty!



TOP FOR YOUR BEST POSSIBLE **RESULTS.**



ROHDE TOPLOADERS



Toploaders Details

ROHDE Toploaders are high-quality kilns for everyday use in professional ceramic workshops. The different kiln series have been continually developed by ROHDE and today incorporate state-of-the-art technology and extreme durability.

Many ceramic workshops appreciate the flexibility and extendability of some models and use this feature to increase the economic efficiency of their firing capacities to obtain the best possible results.

Besides an extensive range of technical features and high-quality workmanship, ROHDE Toploaders offer particular technical features, such as:

Extendability

The kiln volume of some models from the ROHDE Toploader TE series can be increased by up to 50% by simply fitting in an additional heatable extension ring (ZWR).

Mount the ring, connect the kiln to the mains supply and continue working with up to 50% more firing capacity. ROHDE Toploaders are able to meet your increasing requirements at any time.

Reversible kiln stand

This construction developed specially by ROHDE offers significant advantages particularly when it comes to charging the kiln. After safe delivery, the construction allows you to adjust the toploader to an individual working height making loading and unloading of the firing chamber much easier on the back.

Disassembly

All models from the TE series can be disassembled easily. The individual parts can be transported to any operating location and can fit through a doorway of only 55 cm without problem.

Electronic solid-state relays

The power on all ROHDE Toploaders is controlled by electronic solid-state relays. These silent and low-wear high-performance components are operated without mechanical contacts. The solid-state relays are cooled by an external cooling element mounted outside the switch cabinet. This prevents additional heat from getting into the electric control device and guarantees consistent, trouble-free operation.



High, low and flexible.



Solid lid hinge,
pressure spring-supported
opening mechanism for the lid

Fixing device for safe fastening
of the kiln controller

Exhaust air socket to
connect exhaust tube

Silent and low-wear stainless steel
switch cabinet, solid-state relays
with cooling element

Reversible kiln stand,
handy and practical



Practical to transport and practical to extend.

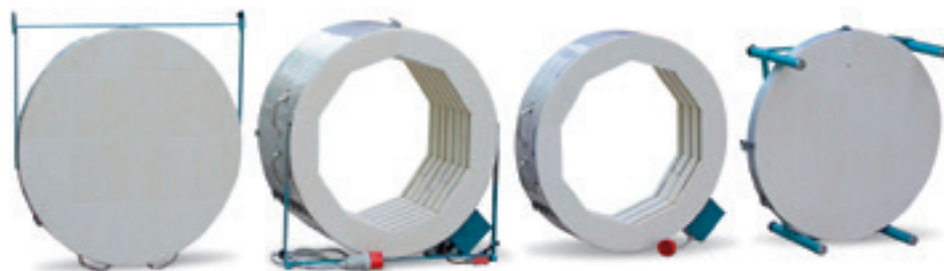

Toploaders Ecotop series

Efficient, safe and economical.

The future-oriented models from the Ecotop series are among the most recent developed kiln range of ROHDE. The Ecotop is currently one of the most economical kilns on the market and features a new and unique insulation concept that allows for very high energy efficiency.

The 3-layer insulation structure featuring a high-quality microporous 15 mm back insulation can be safely fired to stoneware temperatures using a regular 230 V "Schuko" plug connector (3.6 kW).

Special features of the Ecotop series:

- 3-layer insulation concept with 15 mm microporous insulating board
- Particularly high energy efficiency
- Reversible kiln stand, handy and practical
- Pressure spring-supported opening mechanism for the lid
- Power control effected by silent, low-wear solid-state relays with external cooling element



Wall structure with additional microporous back insulation

Reversible kiln stand, handy and practical



Electric Toploaders **ECOTOP** series to 1320°C

Model	Tmax °C	Int. dimensions mm			Ext. dimensions mm			Output kW	Supply A	Connector	Furniture batts w x d mm	Weight kg
		w	d	h	W	D	H					
Ecotop 20	1320	Ø 330	230		640	640	660	2,3	10,0	Schuko	Ø 290	44
Ecotop 43 L	1320	Ø 400	340		700	730	770	2,9	13,0	Schuko	Ø 350	58
Ecotop 50	1320	Ø 400	380		700	730	830	3,6	16,0	Schuko	Ø 350	58
Ecotop 50 S	1320	Ø 400	380		700	730	830	4,5	6,5	CEE 16 A	Ø 350	58
Ecotop 60 L	1200	Ø 400	450		700	730	900	2,9	13,0	Schuko	Ø 350	60
Ecotop 60	1320	Ø 400	450		700	730	900	3,6	16,0	Schuko	Ø 350	60
Ecotop 60 S	1320	Ø 400	450		700	730	900	5,0	7,0	CEE 16 A	Ø 350	60

Toploaders TE-MCC+ series

The solid ROHDE Toploaders from the MCC+ series can be used for a variety of applications ranging from glass processing at 800°C to manufacture of stoneware at 1280°C. Toploaders from this series are particularly suitable for use in public institutions such as schools and kindergartens, as well as for both artists and hobbyists. The wide temperature range allows maximum flexibility when it comes to artistic craftsmanship in the field of ceramics and glass.

Special features of the TE-MCC+ series

Models TE 75, TE 100, TE 130 and TE 200 MCC+ can be fitted easily with a heatable lid required for glass processing. The heating elements are mounted on support rods that prevent particles falling from the kiln lid onto the ware.

Extendability

The kiln volume of four models from the ROHDE Toploader TE series can be increased by 50% by simply fitting in a heatable additional extension ring (ZWR):

- TE 75 MCC to 110 litres volume
- TE 100 MCC to 150 litres volume
- TE 130 MCC to 190 litres volume
- TE 200 MCC to 300 litres volume

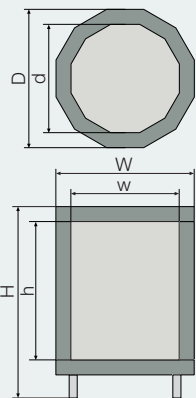

2-layer wall structure
TE-MCC+ series
ROHDE lid heating,
heating elements mounted on
high-quality ceramic support rods



Electric Toploaders TE-MCC+ series to 1320°C

Model	Tmax	Int. dimensions mm			Ext. dimensions mm			Output	Supply	Connector	Furniture batts	Weight
		w	d	h	W	D	H					
TE 75 MCC+	1320	Ø 470	460	760	730	780	6,0	13	CEE 16	Ø 410	82	
ZWR 75 MCC+		Ø 470	230	760	730	230	3,0	-	-	-	23	
TE 110 MCC+	1320	Ø 470	680	760	810	1010	9,0	13	CEE 16	Ø 410	105	
TE 100 MCC+	1320	Ø 520	460	800	800	780	7,0	15	CEE 16	Ø 470	89	
ZWR 100 MCC+		Ø 520	230	800	800	230	3,5	-	-	-	20	
TE 150 MCC+	1320	Ø 520	680	800	870	1000	10,5	15	CEE 16	Ø 470	109	
TE 130 MCC+	1320	Ø 590	460	860	880	780	7,3	16	CEE 16	Ø 540	106	
ZWR 130 MCC+		Ø 590	230	860	880	230	3,7	-	-	-	25	
TE 190 MCC+	1320	Ø 590	680	860	940	1010	11,0	16	CEE 16	Ø 540	125	
TE 200 MCC+	1320	Ø 740	460	1020	1010	780	9,2	20	CEE 32	Cut to size	130	
ZWR 200 MCC+		Ø 740	230	1020	1010	230	4,6	-	-	-	32	
TE 300 MCC+	1320	Ø 740	680	1030	1030	1010	13,8	20	CEE 32	Cut to size	170	

ZWR = Extension ring to increase volume

Special voltage electric supply for all EU networks available on request

Toploaders TE-S series

ROHDE Toploaders from the TE-S series are high-quality kilns for everyday use in professional ceramic workshops. The kilns in this series have been continually developed by ROHDE over the last three decades. Toploaders from the TE-S series guarantee state-of-the-art technology and are characterised by outstanding durability.

Many ceramic workshops appreciate the flexibility and extendability of some models and use this feature to increase the economic efficiency of their firing capacities to obtain the best possible results. Besides an extensive range of technical features and high-quality workmanship, ROHDE Toploaders from the TE-S series offer particular technical features, such as:

Extendability

The kiln volume of four models from the ROHDE Toploader TE-S series can be increased up to 50% by simply fitting in a heatable additional extension ring (ZWR).

- TE 80 S to 100 litres volume
- TE 95 S to 145 litres volume
- TE 130 S to 200 litres volume
- TE 165 S to 250 litres volume

Floor heating

Models of the TE-series from TE 95 S upwards can be equipped with an optional heatable kiln floor. The additional heating provides an even distribution of heat in particular in the lower and middle temperature ranges.

Optional heatable floor
Reversible kiln stand,
handy and practical

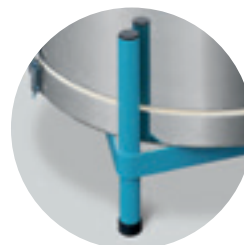

Electric Toploaders **TE-S** series to 1320°C

Model	Tmax	Int. dimensions mm			Ext. dimensions mm			Output	Supply	Connector	Furniture batts	Weight
Volume	°C	w	d	h	W	D	H	kW	A	Plug	w x d mm	kg
TE 80 S	1320	∅ 450	460		790	800	780	6,0	13	CEE 16	∅ 410	99
ZWR 80 S		∅ 450	150		790	800	150	3,0	-	-	-	20
TE 100 S	1320	∅ 450	610		790	850	930	9,0	13	CEE 16	∅ 410	117
TE 95 S	1320	∅ 520	460		850	860	790	7,3	16	CEE 16	∅ 470	113
ZWR 95 S		∅ 520	230		850	860	230	3,7	-	-	-	29
TE 145 S	1320	∅ 520	680		850	910	1020	11,0	16	CEE 16	∅ 470	142
TE 130 S	1320	∅ 610	460		930	930	790	8,8	19	CEE 32	∅ 540	130
ZWR 130 S		∅ 610	230		930	930	230	4,4	-	-	-	33
TE 200 S	1320	∅ 610	680		930	990	1020	13,2	19	CEE 32	∅ 540	166
TE 165 S	1320	730	630	460	1050	930	790	10,0	22	CEE 32	Cut to size	144
ZWR 165 S		730	630	230	1050	930	230	5,0	-	-	-	36
TE 250 S	1320	730	630	680	1050	980	1020	15,0	22	CEE 32	Cut to size	180
TE 300 S	1320	840	640	680	1160	950	1020	15,0	22	CEE 32	Cut to size	204

ZWR = Extension ring to increase volume

Special voltage electric supply for all EU networks available on request

Toploaders Quattro TE-Q series

The Quattro TE-Q series comprises two different designs; the models TE-QN and TE-QS in square design with 4-side heating and elements recessed into grooved bricks, and models TE 70 QT/QTS and 110 QT with 4-side heating and elements mounted on support rods.

Both designs are equipped with a high-quality 2-layer insulation structure that is fitted precisely into a very sturdy frame construction. The high-quality, two-colour industrial lacquer used on the frame turns the Quattro series into attractive ROHDE Toploaders. The in-frame ventilated lid and the use of galvanized steel sheet in the kiln casing provide effective protection against corrosion. Another feature of this design is the carefully manufactured kiln lid, as the round toploader it is provided with a pressure spring that allows easy opening of the lid.

Rectangular toploaders BT series

The BT series combines 5-side heating in robust frontloader construction with all the advantages of a toploader. The high-quality insulation structure and the even temperature distribution make the rectangular toploader suitable for workshop applications where as many ceramic products as possible must be placed and processed at one firing process. During kiln charging, the rectangular toploader offers an excellent overview of the ware to obtain the best possible results.



2-layer wall structure,
heating elements mounted in protected
position recessed into grooved bricks

Easy lid opening and closing
using gas pressure springs

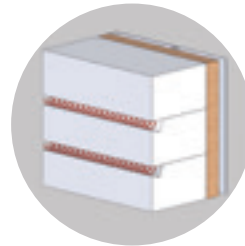

Electric Toploaders **TE-Q** and **BT** series to 1320°C

Model	Tmax °C	Int. dimensions mm			Ext. dimensions mm			Output kW	Supply A	Connector Plug	Furniture batts w x d mm	Weight kg
		w	d	h	W	D	H					
TE 10 Q	1320	180	230	230	390	600	560	1,8	- 8	Schuko	200 x 150	30
TE 35 Q	1320	380	380	230	630	780	570	3,6	- 16	Schuko	370 x 340	81
TE 50 QN	1320	380	380	340	630	780	680	3,6	- 16	Schuko	370 x 340	100
TE 50 QS	1320	380	380	340	630	780	680	5,0	11 22	CEE 16	370 x 340	100
TE 70 QT	1250	410	410	420	730	870	760	3,6	- 16	Schuko	350 x 350	145
TE 70 QT-S	1320	410	410	420	730	870	760	6,0	13 26	CEE 16	350 x 350	150
TE 110 QT	1320	450	450	530	800	920	870	9,0	13 40	CEE 16	400 x 400	250
BT 300	1320	920	570	610	1360	970	1070	15,0	25 -	CEE 32	500 x 400	400
BT 500	1320	1150	650	690	1620	1050	1150	24,0	34 -	CEE 63	600 x 500	535

Hood kilns HE series

ROHDE Hood kilns from the HE series are the consequent technical development of the Toploader TE-S series. As there are limits to top loading, ROHDE Hood kilns are a practical and efficient alternative to the larger models from the Toploader TE-S series.

These models do not require top or front loading, but the entire kiln must be positioned easily and without effort like a hood over the ware to be fired. This allows individual large pieces to be positioned freely on the kiln floor.

The design makes charging the kiln floor with ceramics remarkably easy on the back. The proven, highly flexible ROHDE ring system allows for almost every concept, such as individual pieces with diameters up to 1.5 m or kilns with (almost) any internal heights.

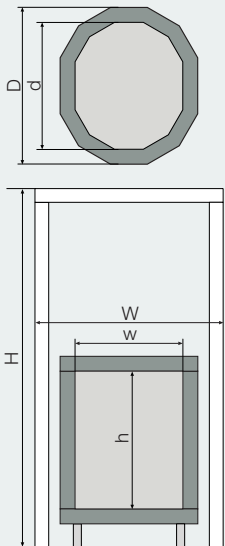

Smooth and easy rope winch for safe and effortless lifting of the kiln hood

Easy moving of the kiln floor using a pallet truck makes it accessible for charging

Kiln floor on optional rails allows safe charging of large workpieces

An optional hydraulic system allows the hood to be easily moved

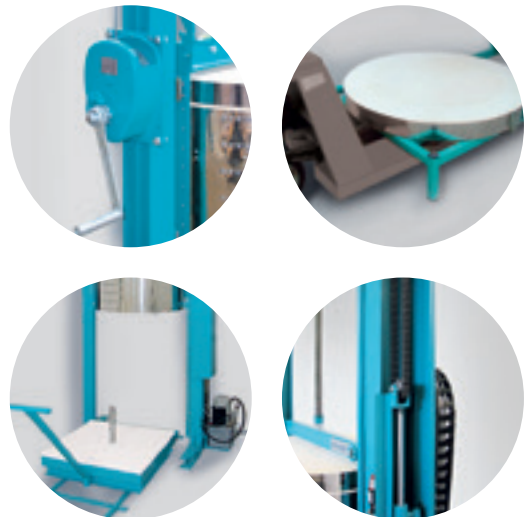

Electric Hood kilns **HE** series to 1320°C

Model	Tmax °C	Int. dimensions mm			Ext. dimensions mm			Output kW	Supply A	Connector Plug	Furniture batts w x d mm	Weight kg
		w	d	h	W	D	H					
HE 200	1320	∅ 610	680		1500	850	2210	13	19	CEE 32	∅ 540	235
HE 260	1320	∅ 610	910		1500	850	2400	18	25	CEE 32	∅ 540	270
HE 250	1320	640	730	680	1500	1250	2250	15	22	CEE 32	Cut to size	270
HE 330	1320	640	730	910	1500	1250	2480	20	30	CEE 32	Cut to size	310
HE 300	1320	640	840	680	1500	1080	1800	17	24	CEE 32	Cut to size	300
HE 400	1320	640	840	910	1500	1080	2440	22	32	CEE 32	Cut to size	340



ROHDE Electric Toploaders **Overview**

Features	Ecotop	TE-MCC+	TE-S	HE	TE-Q N/S	TE-QT	BT
End temperature	1320°C*	1320°C	1320°C	1320°C	1320°C	1320°C*	1320°C
All around heating	•	•	•	•	•	•	•
Floor heating	-	-	◦	◦	-	-	•
Lid heating	-	◦	-	-	-	-	-
Electronic solid-state relays	•	•	•	◦	◦	◦	◦
Heating elements in grooved bricks	•	•	•	•	•	-	•
Heating elements on support rods	-	-	-	-	-	•	-
Reversible kiln stand, handy and practical	•	•	•	-	-	-	-
Exhaust air socket	•	•	•	•	•	•	•
View port	◦	◦	◦	◦	◦	◦	◦
Support for controller	•	•	•	-	-	-	-
Air supply slide	•	•	•	•	-	-	-
Can be disassembled for transport	•	•	•	•	-	-	◦
Can be extended	-	•	•	-	-	-	-
3 year warranty	•	•	•	•	•	•	•
CE conformity marking	•	•	•	•	•	•	•

• Standard equipment

◦ Optional

- Not available

* Not available for all models



TREASURY OF
YOUR **SKILLS.**

ROHDE FRONTLOADERS





1001

Frontloaders to 1320°C



Advantages in detail



Corrosion protection and low external temperature due to in-frame ventilation



Silent, low wear solid-state relay with external cooling element



Connector for controller and micro-fuse easily accessible



New exhaust air flap handle with larger exhaust air opening



Security switch mounted in protected position



Adjustable door catch, lockable



Air supply slide operated from front, improved air supply handling

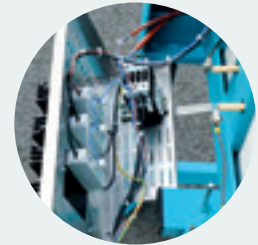

Compact, easy-to-open assembly of electrical components at back of kiln



2-layer wall structure for KE-L / KE-N series

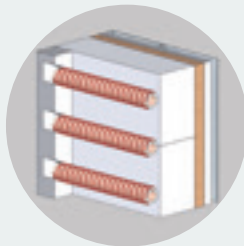

3-layer wall structure for KE-S / S+ / ELS series

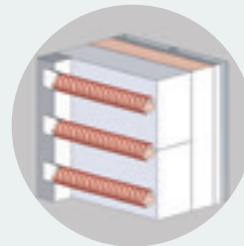

3-layer wall structure for KE-SH series

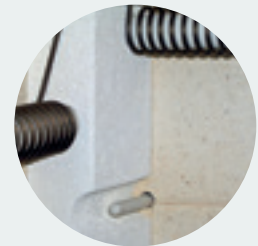

Thermocouple mounted in protected position



Heating elements mounted on support rods for KE-S / S+ / SH / ELS series

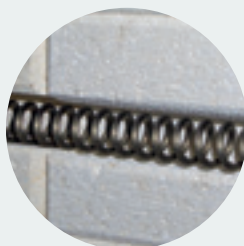

Heating elements recessed into grooved bricks for KE-L / KE-N series



R-SiC ceiling support „System ROHDE“ prevents cracks and particles falling from the ceiling onto the ware



Adjustable door hinge, easy dismantling of door for transport

Frontloaders KE-L series

The Frontloader KE-L series comprises models with 3-side heating and kiln volumes between 55 and 250 litres. You can choose between the compact tabletop models KE 55 L and KE 70 L as well as four standing models KE 100 L to KE 430 L.

Frontloaders from the KE-L series are particularly suitable for use in public institutions, such as schools, kindergartens and therapy centres. These electrically operated kilns offer best possible performance and a variety of options for hobby and decorative applications or casting techniques. The advantages of a frontloader can be effectively used, ensuring a balanced price-to-performance ratio.

The unique technical features of ROHDE Frontloaders have been incorporated into the KE-L series. The entire in-frame ventilated steel construction prevents corrosion and at the same time reduces external temperatures. The proven ceiling construction "System ROHDE" has also been incorporated into the KE-L series.

Heat is radiated from heating elements mounted into the two side walls and the floor, resulting in an efficient, even distribution of heat throughout the whole firing chamber to obtain the best possible results.

ROHDE Frontloaders from the KE-L series can be extended with optional accessories and equipment such as an air supply slide or an exhaust air flap handle.

Special features of the KE-L series:

- 3-side heating resulting in even heat distribution
- Heating elements recessed in protected position into grooved bricks
- In-frame ventilation for low external temperatures and corrosion protection
- 2-layer insulation structure
- R-SiC ceiling support "System ROHDE" prevents cracks and particles falling from the ceiling onto the ware



KE 55 L

All around in-frame ventilated casing reduces external temperatures and prevents corrosion

Stable door construction, easy to adjust

3-side heating from sides and floor, heating elements recessed into grooved bricks

Security switch mounted in protected position



Foto Patricia Schichl



KE 200 L

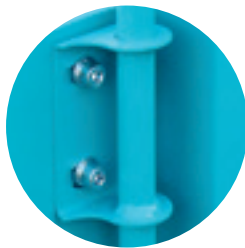

Electric Frontloaders **KE-L** series to 1280°C

Model	Tmax	Int. dimensions mm			Ext. dimensions mm			Output	Supply	Connector	Furniture batts	Weight	
		Volume	°C	w	d	h	W						D
KE 55 LN	1200		410	380	340	660	700	770	3,0	13	Schuko	370 x 340	111
KE 55 L	1280		410	380	340	660	700	770	3,6	16	Schuko	370 x 340	111
KE 70 L	1050		410	380	450	660	700	880	3,6	16	Schuko	370 x 340	121
KE 70 LS	1280		410	380	450	660	700	880	5,5	8,5	CEE 16 A	370 x 340	124
KE 100 L	1280		430	480	530	750	1050	1630	7,0	16	CEE 16 A	400 x 370	309
KE 150 L	1280		480	480	680	800	1050	1700	9,0	13	CEE 16 A	440 x 400	338
KE 200 L	1280		480	640	680	800	1210	1700	11,0	16	CEE 16 A	600 x 400	406
KE 250 L	1280		560	640	760	870	1200	1740	13,5	20	CEE 32 A	600 x 500	460
KE 430 L	1280		650	640	1110	960	1140	1910	22,0	32	CEE 32 A	600 x 500	535

Special voltage electric supply for all EU networks available on request

Frontloaders KE-N series

ROHDE Frontloaders from the KE-N series comprise six models with kiln volumes between 100 and 480 litres. The heating elements are recessed into grooved firebricks on all five wall sides.

The KE-N series has been designed for use in workshops and schools. The heating elements in this series have been recessed into grooved bricks. This results in a variety of advantages. The heating elements are protected while the kiln is being charged, power output is constant and heat is evenly distributed throughout the firing chamber, providing the best possible results.

Special features of the KE-N series:

- 5-side heating resulting in even heat distribution
- Heating elements recessed into grooved bricks
- Stainless steel in-frame ventilation resulting in low external temperatures and corrosion protection
- 2-layer insulation structure
- R-SiC ceiling support "System ROHDE" prevents cracks and particles falling from the ceiling onto the ware



KE 200 N

Heating elements recessed in protected position into grooved bricks

Adjustable door hinge, easy dismantling of door for transport

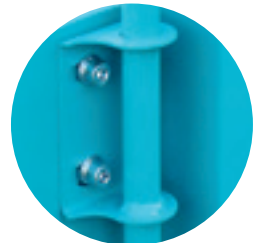
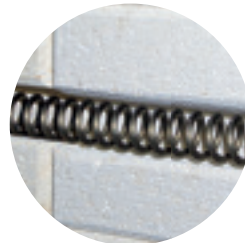

Electric Frontloaders **KE-N** series to 1300°C

Model	Tmax	Int. dimensions mm			Ext. dimensions mm			Output	Supply	Connector	Furniture batts	Weight
Volume	°C	w	d	h	W	D	H	kW	A	Plug	w x d mm	kg
KE 100 N	1300	410	480	530	750	1050	1700	6,6	10	CEE 16 A	400 x 370	323
KE 150 N	1300	460	480	680	800	1050	1780	9,0	13	CEE 16 A	440 x 400	375
KE 200 N	1300	460	640	680	800	1210	1780	11,0	16	CEE 16 A	600 x 400	415
KE 250 N	1300	530	640	760	870	1210	1800	13,7	22	CEE 32 A	600 x 500	471
KE 330 N	1300	590	720	790	920	1280	1800	16,5	25	CEE 32 A	550 x 340 (2)	531
KE 480 N	1300	640	770	980	980	1340	1830	22	32	CEE 32 A	600 x 360 (2)	641

Frontloaders KE-S series

ROHDE Frontloaders from the KE-S series comprise nine models with kiln volumes between 100 and 1000 litres. The heating elements are mounted on support rods. 5-side heating provides even distribution of heat throughout every performance range.

The KE-S series was designed for daily use over many years in professional workshops at firing temperatures up to 1320°C. However, they are also suitable for everyday applications in schools, providing the best possible results.

Special features of the KE-S series:

- 5-side heating resulting in even heat distribution
- Heating elements mounted on support rods
- Stainless steel in-frame ventilation resulting in low external temperatures and corrosion protection
- 3-layer insulation structure
- R-SiC ceiling support "System ROHDE" prevents cracks and particles falling from the ceiling onto the ware



KE 200 S

Heating elements mounted on support rods

Door handle with new design and handy stainless steel pipe

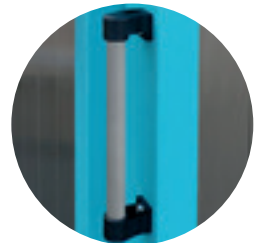

Electric Frontloaders **KE-S** series to 1320°C

Model	Tmax	Int. dimensions mm			Ext. dimensions mm			Output	Supply	Connector	Furniture batts	Weight
Volume	°C	b	t	h	B	T	H	kW	A	Plug	w x d mm	kg
KE 100 S	1320	410	470	540	750	1040	1700	8,0	12	CEE 16 A	400 x 370	324
KE 150 S	1320	460	470	690	800	1050	1780	10,5	16	CEE 16 A	420 x 400	363
KE 200 S	1320	460	630	680	800	1210	1770	13,2	20	CEE 32 A	560 x 400	416
KE 250 S	1320	540	630	760	870	1200	1810	16,5	25	CEE 32 A	600 x 480	470
KE 330 S	1320	590	720	800	930	1280	1800	22,0	32	CEE 32 A	600 x 500	529
KE 480 S	1320	640	770	1020	980	1340	1830	32,0	47	CEE 63 A	580 x 350 (2)	630
KE 600 S	1320	720	870	1030	1460	1430	2040	40,0	59	CEE 63 A	370 x 335 (4)	1020
KE 750 S	1320	720	1100	1030	1570	1690	2010	50,0	73	-	475 x 335 (4)	1122
KE 1000 S	1320	920	1070	1140	1660	1610	2040	70,0	100	-	480 x 435 (4)	1250

Special voltage electric supply for all EU networks available on request

Frontloaders ELS series Ergo Load System

The newly developed ROHDE kiln concept ELS Ergo Load System is a unique kiln series that makes the daily charging routine significantly easier, safer and easier on the back. It is a ROHDE patent-registered kiln concept.

The smooth running mechanism of this kiln type allows the kiln floor to be pulled out completely so that the whole charging surface can be freely accessed. This makes it not only faster, safer and more efficient to load the kiln but also improves the setting density of the kiln by 20% thus saving time and energy and reducing firing costs. Even heavy components such as furniture batts can be positioned in the ELS series ergonomically without problem.

The unique technical features of ROHDE Frontloaders have been incorporated into this series. The entire steel construction is equipped with an in-frame ventilation made of stainless steel sheets. The insulation comprises three layers using only high-quality, reduction-resistant insulating firebricks inside the firing chamber.



ELS 200 S

Heating elements mounted on support rods

Easy charging on three sides when the kiln floor is pulled out



Electric Frontloaders **ELS** series to 1320°C

Model	Tmax °C	Int. dimensions mm			Ext. dimensions mm			Output kW	Supply A	Connector Plug	Furniture batts w x d mm	Weight kg
		w	d	h	W	D	H					
ELS 200 S	1320	460	620	680	800	1250	1670	13,2	20	CEE 32 A	560 x 400	550
ELS 330 S	1320	590	720	800	930	1310	1840	22,0	32	CEE 32 A	600 x 500	690
ELS 480 S	1320	640	770	995	980	1370	1970	32,0	47	CEE 64 A	580 x 350 (2)	800
ELS 750 S	1320	720	1100	1030	1430	1680	1970	50,0	73	-	480 x 330 (2)	1350
ELS 1000 S	1320	920	1060	1145	1590	1680	2100	70,0	100	-	470 x 435 (2)	1500



ELS 480 S

Ergonomical. Practical. Logical.
THE ROHDE ELS **ERGO LOAD SYSTEM**



Frontloaders KE-S+ series

ROHDE Frontloaders from the KE-S+ series comprise six models with kiln volumes between 100 and 480 litres. The heating elements are mounted on support rods. 5-side heating provides even distribution of heat throughout every performance range.

The KE-S+ series was designed for demanding applications and use over many years in professional workshops. The 3-layer microporous insulation structure allows for maximum firing temperatures of 1350°C providing the best possible results.

Special features of the KE-S+ series:

- 5-side heating resulting in even heat distribution
- Heating elements mounted on support rods
- Stainless steel in-frame ventilation resulting in low external temperatures and corrosion protection
- 3-layer insulation structure
- R-SiC ceiling support "System ROHDE" prevents cracks and particles falling from the ceiling onto the ware



KE 200 S+

Security switch mounted in protected position

3-layer wall structure KE-S+ series

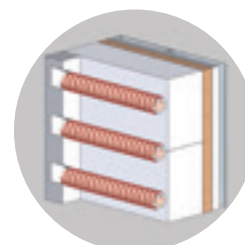

Electric Frontloaders **KE-S+** series to 1350°C

Model	Tmax	Int. dimensions mm			Ext. dimensions mm			Output	Supply	Connector	Furniture batts	Weight
Volume	°C	w	d	h	W	D	H	kW	A	Plug	w x d mm	kg
KE 100 S+	1350	410	470	540	750	1040	1700	8,0	12	CEE 16 A	400 x 370	340
KE 150 S+	1350	460	470	690	800	1050	1780	10,5	16	CEE 16 A	420 x 400	385
KE 200 S+	1350	460	630	680	800	1210	1770	13,2	20	CEE 32 A	560 x 400	434
KE 250 S+	1350	540	630	760	870	1200	1810	16,5	25	CEE 32 A	600 x 480	523
KE 330 S+	1350	590	720	800	930	1280	1800	22,0	32	CEE 32 A	600 x 500	554
KE 480 S+	1350	640	770	1020	980	1340	1830	32,0	47	CEE 63 A	580 x 350 (2)	693

Special voltage electric supply for all EU networks available on request

Frontloaders KE-SH series

ROHDE Frontloaders from the KE-SH series comprise six models with kiln volumes between 100 and 480 litres. The heating elements are mounted on support rods. 5-side heating provides even distribution of heat throughout every performance range.

The KE-SH series was designed for demanding applications and use over many years in professional workshops. The highly durable heating elements and the specific 3-layer wall structure allow for maximum temperatures of 1400°C and obtaining the best possible results.

Special features of the KE-SH series:

- 5-side heating resulting in even heat distribution
- Heating elements mounted on support rods
- Stainless steel in-frame ventilation resulting in low external temperatures and corrosion protection
- 3-layer insulation structure
- R-SiC ceiling support "System ROHDE" prevents cracks and particles falling from the ceiling onto the ware



KE 200 SH

Air supply slide operated from front,
improved air supply handling

3-layer wall structure KE-SH series

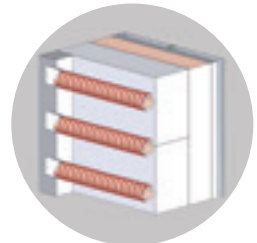

Electric Frontloaders **KE-SH** series to 1400°C

Model	Tmax °C	Int. dimensions mm			Ext. dimensions mm			Output kW	Supply A	Connector Plug	Furniture batts w x d mm	Weight kg
		w	d	h	W	D	H					
KE 100 SH	1400	410	480	530	810	1120	1700	10,5	16	CEE 16 A	400 x 370	403
KE 150 SH	1400	460	475	680	860	1130	1790	15,0	22	CEE 32 A	420 x 400	492
KE 200 SH	1400	460	640	680	860	1280	1790	18,0	26	CEE 32 A	560 x 400	558
KE 250 SH	1400	520	630	770	1020	1270	1840	24,0	34	CEE 63 A	560 x 480	625
KE 330 SH	1400	580	710	800	1080	1350	1840	32,0	47	CEE 63 A	600 x 500	690
KE 480 SH	1400	630	770	995	1130	1410	1860	40,0	59	CEE 63 A	580 x 350 (2)	800

Special voltage electric supply for all EU networks available on request

ROHDE - FIRMLY SET IN **QUALITY.**

ROHDE 

Optional accessories for Electric Frontloaders



Exhaust air flap handle, motor-driven, retrofittable



Air supply slide, motor-driven, retrofittable



Powerful cooling system



Door opening to the left

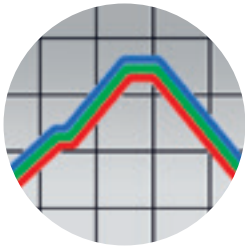

Multiple-zone control for best reproducibility and good temperature distribution



View port for monitoring of Seger cones



Drying rack for top of kiln



Forklift loading frame

ROHDE Electric Frontloaders Overview

Features	KE-L	KE-N	KE-S/S+/SH	ELS
Corrosion protection and low external temperature due to in-frame ventilation	•	•	•	•
In-Frame ventilation using stainless steel sheets on both side walls and door	-	•	•	•
Ceiling sheet: punched metal sheet prevents accumulation of heat and moisture	•	•	•	•
5-side all around heating resulting in even heat distribution	-	•	•	•
Kanthal A1 heating elements, mounted in protected position against displacement	•	•	•	•
Floor heating elements covered and protected by SiC batts	◦	•	•	•
Patented R-SiC ceiling support „System ROHDE“	•	•	•	•
Thermocouple mounted in protected position	•	•	•	•
Stainless steel door frame	•	•	•	•
Door opens easily to approx. 180°, elastic door sealing	•	•	•	•
Exhaust air socket Ø 80mm to connect exhaust tube	◦	•	•	•
Exhaust air opening with flap handle, operated from front *	◦	•	•	•
Large, practical door handle	•	•	•	•
Adjustable door catch, lockable	•	•	•	•
Air supply slide enabling control of cooling air, operated from front	◦	•	•	•
Legs detachable and easy mounting **	•	•	•	•
Safety and control contactors according to VDE standards	•	•	•	•
Automatic kiln control	•	•	•	•
Silent, low-wear solid-state relay	•	•	•	•
Swivel-mounted support for controller	•	•	•	•
Door opening to the left (controller right)	◦	◦	◦	◦
End temperature 1350°C or 1400°C	-	-	◦	-
View port in door to monitor firing	◦	◦	◦	◦
Air supply and exhaust air flap handle control *** ****	◦	◦	◦	◦
Cooling system with ventilation ****	-	-	◦	◦
Flexible exhaust air hose made of aluminium	◦	◦	◦	◦
Drying rack for top of kiln *	◦	◦	◦	◦
Forklift loading frame *	◦	◦	◦	-
Seal of approval for quality control	•	•	•	•
CE conforming marking	•	•	•	•
Maintenance-free, 3-year warranty (not on parts subject to wear)	•	•	•	•

• Standard equipment • Optional - Not available * Not available for KE 55 / 70L ** Optional Kiln stand for KE 55 / 70L

*** Optional only in connection with controller TC 504 / 507. For detailed configurations, please see valid price list.

**** Not available for KE / ELS 200 / 330 S



A BURNING PASSION
FOR THE BEST POSSIBLE **RESULTS.**

ROHDE GAS AND RAKU



Gas Toploaders TG series

Gas-fired ROHDE Toploaders from the TG series combine high-level technology with economic efficiency. ROHDE gas technology is easy and safe to handle. It can be controlled individually and has very low energy consumption providing at the same time the best possible results.

Downdraft flame control technology ensures even temperature distribution. The extremely silent high-performance intermediate pressure burners were developed specially for gas-fired ROHDE Toploaders. They ensure an optimal temperature rise even in the high temperature range and allow stable atmospheric control during firing. Reduction control is carried out manually using a flue slide. All models from the TG series are equipped with view ports to allow monitoring of the firing process using Seger cones. The gas fittings including safety technology are pre-installed for connection to gas bottles or gas lines according to DVGW (DVGW German Technical and Scientific Association for Gas and Water). A thermocouple with temperature meter is also supplied with the kiln.

You can choose the ROHDE Servo Jet equipment for firing a Toploader from the TG series with natural gas.

Special features of the TG series:

- Downdraft flame control technology
- Ring system, can be disassembled for transport and movement
- Pressure spring-supported opening mechanism for the lid
- Burner systems for propane, butane and natural gas

Special equipment:

- Oxygen probe for atmospheric measurement
- CO alarm and monitoring device
- ROHDE Servo Jet equipment for working with natural gas
- Stainless steel hood
- Castors, stable and robust



TG 80



Gas Toploaders **TG** series to 1320°C

Model	Tmax °C	Int. dimensions mm			Ext. dimensions mm			Output kW	Burners Quantity	Furniture batts w x d mm	Weight kg
		w	d	h	W	D	H				
TG 80	1320	520	500	450	870	800	760	20	1	Ø 420	120
TG 170	1320	650	640	530	1020	930	830	40	2	Ø 550	150
TG 220	1320	650	640	690	1020	930	990	40	2	Ø 550	180
TG 270	1320	770	640	690	1130	930	990	40	2	Special	200

Gas Frontloaders KG series

Gas-fired Frontloaders from the KG series comprise several models with kiln volumes between 250 and 1000 litres. These kilns were designed for use in work-shops. Based on the design of electric frontloaders, the entire steel construction is equipped with in-frame ventilation made of stainless steel sheets. The R-SiC ceiling support "System ROHDE" prevents cracks and particles falling from the ceiling onto the ware.

Downdraft flame control technology ensures even temperature distribution also in the KG series. The extremely silent high-performance intermediate pressure burners were developed specially for gas-fired ROHDE Frontloaders. They ensure an optimal temperature rise even in the high temperature range and allow a stable atmospheric control during firing. The gas fittings including safety technology are pre-installed for connection to gas bottles or gas lines according to DVGW (DVGW German Technical and Scientific Association for Gas and Water). A thermocouple with temperature meter is supplied with the kiln.

You can choose the ROHDE Servo Jet equipment for firing a Frontloader from the KG series with natural gas.

Special features of the KG series:

- Downdraft flame control technology
- R-SiC ceiling support "System ROHDE" prevents cracks and particles falling from the ceiling onto the ware
- Stainless steel hood
- Stainless steel in-frame ventilation resulting in low external temperatures and corrosion protection
- Burner systems for propane and natural gas

Special equipment:

- Oxygen probe for atmospheric measurement
- CO alarm and monitoring device
- ROHDE Servo Jet equipment for working with natural gas
- Castors, stable and robust



KG 500 A



Gas Frontloaders **KG** series to 1320°C

Model	Tmax °C	Int. dimensions mm			Ext. dimensions mm			Output kW	Burners Quantity	Furniture batts w x d mm	Weight kg
		w	d	h	W	D	H				
KG 250 A	1320	540	670	760	1190	1035	1880*	40	2	600 x 500	590
KG 340 A	1320	700	760	760	1510	1240	1880*	80	4	550 x 340 (2)	800
KG 500 A	1320	610	870	980	1420	1360	2210*	80	4	560 x 380 (2)	900
KG 750 A	1320	830	890	1140	1640	1390	2360*	80	4	400 x 400 (4)	1020
KG 1000 A	1320	830	1050	1210	1640	1550	2440*	120	6	480 x 400 (4)	1250

* incl. detachable stainless steel hood

Raku Toploaders TR series

ROHDE Toploaders from the TR series for raku applications stand for easy handling, durability and flexibility. Toploaders from the TR series are easy to transport and problem-free to handle. High standard technology such as a V2A stainless steel jacket or a stable structure made of lightweight firebricks guarantee sturdiness and long service life.

ROHDE Toploaders from the TR series have very low energy consumption at remarkably short heating rates. For this purpose, ROHDE developed a silent 30 kW high-performance burner that is easy to regulate especially for this series.

All models of the TR series can be disassembled into ring segments for transport. Benefit from the extendability of the model TR 80 Vario by fitting in an extension ring for more flexibility.

Special features of the TR series:

- Lid easy-to-open supported by gas pressure springs (not for TR 80 Vario)
- Reduction-resistant lightweight firebrick lining of the firing chamber
- Sturdy kiln frame with handles allowing effortless transportation
- ROHDE Raku burner equipment for use with propane and butane gas, powerful and silent
- View port to monitor firing

Complete Raku burner kit:

- Atmospheric 30 kW raku burner for use with propane gas
- Hose connection including pressure control and manometer for connection to bottle
- Digital temperature meter up to 1150°C (battery operated)
- Thermocouple NiCr/Ni NL 130 to 1150°C

Special equipment:

- Castors, stable and robust



TR 80



Raku Toploaders **TR** series to 1150°C

Model	Tmax °C	Int. dimensions mm			Ext. dimensions mm			Output kW	Burners Quantity	Furniture batts w x d mm	Weight kg
		w	d	h	W	D	H				
TR 44	1150	400	400	350	620	650	790	30	1	Ø 350	60
TR 80	1150	460	460	500	680	710	840	30	1	Ø 350	80
TR 80 Vario	1150	430	480	460	800	680	790	20	1	Ø 420	120
ZWR 80	-	430	480	230	800	680	790	-	-	-	24
TR 170	1150	610	610	580	850	850	920	30	1	Ø 540	120

ZWR = Extension ring to increase volume

Raku Frontloaders KR series

This kiln series combines high-level raku technology with all the advantages of a frontloader. The V2A stainless steel jacket and side wall structure made of lightweight firebricks guarantee extreme sturdiness and a long service life. The material used in the kiln door and back is free of ceramic fibre, thus reducing weight. Thanks to a remarkably handy door construction, the kiln door opens easy and wide even when using commercial raku gloves.

Special features of the KR series:

- Reduction-resistant lightweight firebrick lining of the firing chamber
- Kiln door and back made in ceramic fibre module design
- Sturdy kiln frame allowing effortless transportation
- ROHDE-Raku burner equipment for use with propane and butane gas, powerful and silent

Complete Raku burner kit:

- Atmospheric 30 kW raku burner for use with propane gas
- Hose connection including of pressure control and manometer for connection to bottle
- Digital temperature meter up to 1150°C (battery operated)
- Thermocouple NiCr/Ni NL 130 to 1150°C

Special equipment:

- Drying rack, handy and practical
- Castors, stable and robust



KR 70



Raku Frontloaders **KR** series to 1150°C

Model	Tmax °C	Int. dimensions mm			Ext. dimensions mm			Output kW	Burners Quantity	Furniture batts w x d mm	Weight kg
		w	d	h	W	D	H				
KR 70	1150	400	450	430	630	630	870	30	1	370 x 340	80
KR 150	1150	610	570	510	840	760	960	30	1	550 x 500	125



LET'S CALL IT - **GLASS.**

ROHDE FUSING KILNS



Toploaders TE-MCC+ DH series

The concept of these toploaders with lid heating is based on the proven ROHDE Toploader TE-MCC+ series. They allow flexible use and, after extending with a heatable lid, are suitable for ceramic applications and glass processing such as Pâte-de-verre, glass casting, pre-heating or fusing.

The lid heating elements are mounted on high-quality support rods and are optimally fixed enabling free radiation of heat. The unique fixing of heating elements to the kiln lid prevents particles falling from the lid insulation and enables the use of the top furniture layer without restriction.

The lid heating can be switched on or off on request. When operated with a TC 504 or TC 507 controller, an optional automatic 2-zone control can be used. The kiln volume of ROHDE Toploaders with lid heating can be increased by fitting in an extension ring. This allows operation of the lid heating or the extension ring.

Benefit from a ROHDE Toploader of the TE-MCC+ series with lid heating for your applications and discover the numerous varieties of thermal glass processing.



TE 75-MCC+ DH

Lid heating mounted on support rods
Reversible kiln stand, handy and practical

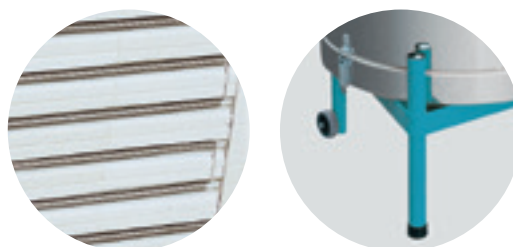

Electric Toploaders TE-MCC+ DH series to 1320°C

Model	Tmax °C	Int. dimensions mm			Ext. dimensions mm			Output kW	Supply A	Connector Plug	Furniture batts w x d mm	Weight kg
		w	d	h	W	D	H					
TE 75 MCC+ DH	1320	Ø 470	460	770	820	820	9,0	13	CEE 16 A	Ø 410	82	
TE 100 MCC+ DH	1320	Ø 520	460	810	860	820	10,5	15	CEE 16 A	Ø 470	89	
TE 130 MCC+ DH	1320	Ø 590	460	870	940	820	8,8	16	CEE 16 A	Ø 540	106	
TE 200 MCC+ DH	1320	Ø 740	460	1000	1050	820	12,5	20	CEE 32 A	Cut to size	130	

Fusing kilns Fusing 40 and Fusing 230

The concept of ROHDE Fusing kilns is based on proven ROHDE Toploader kiln building technology which has been continually developed further for 30 years. The models Fusing 230 and Fusing 40 are designed as tabletop models and are therefore suitable for integration into any workshop environment. This kiln concept consists of an integrated kiln controller providing the highest flexibility. With a storage capacity for 15 programs each with 15 segments, this controller covers almost any requirement in fusing applications and guarantees the best possible results.

Special features of the Fusing series:

- Insulation structure made of lightweight firebricks, free of ceramic fibres
- High-quality infrared radiators
- Low external temperatures at maximum temperature 950°C
- Power control effected by silent, low-wear solid-state relays with external cooling element
- Lid easy-to-open supported by gas pressure springs
- Comfortable and compact kiln control, integrated into kiln body

Controller TC 2088e

- Saves up to 15 programs
- Each program with 15 segments
- Clear and easy-to-read display
- Additional switch outputs optional e.g. for signalling devices etc.
- Intuitive operating layout, modern design
- USB interface optional for WinConfig and WinControl

Controller TC 2088e

Pressure spring-supported opening mechanism for the lid



Fusing 230



Fusing 40



Electric Fusing kilns **Fusing** series to 950°C

Model	Tmax °C	Int. dimensions mm			Ext. dimensions mm			Output kW	Supply A	Connector Plug	Volume Litres	Weight kg
		w	d	h	W	D	H					
Fusing 40 L	950	500	400	210	850	650	510	2,9	13	Schuko	42,0	70
Fusing 40	950	500	400	210	850	650	510	3,6	16	Schuko	42,0	70
Fusing 230	950	1020	660	320	1350	1100	630	11,0	16	CEE 16 A	218,4	170

Fusing kilns FE series

ROHDE Fusing kilns from the FE series guarantee high-level kiln technology. Modern construction principles and the use of high-quality materials allow safe and effective processing of glass. The entire steel construction of the FE series has been designed to be resistant to distortion and its stainless steel components can be exposed regularly to heat.

The flexible FE series is equipped with a kiln frame on stable and sturdy castors (fixed to the kiln stand for models FE 75/100) allowing good workshop organization. The hoods on models FE 75 to 1000 are provided with gas pressure springs that allow safe, easy opening of the lids. You can choose an optional electrically operated lid opening for all ROHDE Fusing kilns from the FE series.

The insulation structure of ROHDE Fusing kilns consists of a solid working surface made of insulating bricks combined with a high-quality manufactured fibre lid. ROHDE ensures that the fibres used have abrasion resistant surfaces to prevent particles falling from the ceiling or contaminating the ware. View ports are installed in the side walls preventing particles falling from the ceiling while the lid is open and offering the best possible overview of the entire firing surface.

The model FE 1800 has been designed as hood kiln in portal construction. The kiln hood is lifted vertically using a manual device thus allowing easy handling of large-surface workpieces and positioning of compact elements on the entire firing surface. After lifting the hood, the worktable can be moved freely. The lifting movement can be operated using an optional hydraulic mechanism.

All ROHDE Fusing kilns from the FE series are equipped with high-quality infrared quartz radiators. Power is controlled by silent, low-wear solid-state relays. Benefit from this combination of fibre insulation, heating with quartz radiators and power control using solid-state relays to obtain exact and safe firing control for your applications and at the same time the best possible results.



FE 100 N/S with optional kiln stand

Hinge and opening mechanism, stable and robust



Detlef Tanz, Fusing-Expert



FE 250



FE 600

Pressure spring-supported opening mechanism for the lid

Large, practical lid handle with extension enabling easy and safe work processes

High-quality quartz radiators resulting in effective and even heat distribution

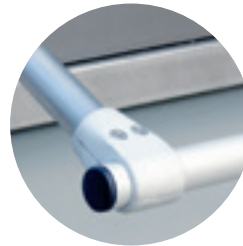

Electric Fusing kilns **FE** series to 1000°C

Model	Tmax °C	Int. dimensions mm			Ext. dimensions mm			Output kW	Supply A	Connector Plug	Working height Top edge mm	Weight kg
		w	d	h	W	D	H					
FE 75 *	1000	520	520	300	830	980	560	3,6	16	Schuko	350	160
FE 100 S*	1000	520	520	380	810	980	560	7,0	10	CEE 16	350	190
FE 250	1000	1100	600	410	1440	1170	1369	11,0	16	CEE 16	800	325
FE 460	1000	1200	950	460	1630	1550	1500	11,0	16	CEE 16	800	450
FE 600	1000	1700	850	460	2160	1470	1400	15,0	22	CEE 32	800	600
FE 1000 N	1000	2200	1200	410	2590	1870	1370	22,0	32	CEE 32	800	800
FE 1000 S	1000	2200	1200	410	2590	1870	1370	30,0	43	CEE 63	800	800
FE 1800 **	1000	3050	1550	410	3500	1900	1900	43,0	63	CEE 63	800	1600

*Tabletop models (optional kiln stand) **Designed as hood kiln

CONTROL YOUR **BEST POSSIBLE RESULTS.**

ROHDE CONTROLLERS



Kiln controller TC 304

Range of application:
Ceramics, laboratory

Clearly structured control unit and easy to operate, for use in workshops, schools and hobby rooms.

- 5 firing programs, freely adjustable
- Delayed start programmable
- 1 dwell/soak time freely programmable

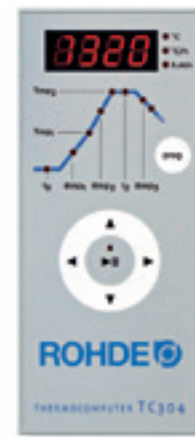

Kiln controller TC 504

Range of application:
Ceramics, laboratory, heat treatment

High-performance control unit with highest security standard and high comfort suitable for demanding workshop and laboratory applications. Equipped with 2- or 3-zone control (optional).

- 10 firing programs, freely adjustable
- Delayed start programmable
- 2 dwell/soak times freely programmable
- 1 additional switch output



Kiln Controllers TC 304 and TC 504

Technical data	TC 304	TC 504
Control range / Steps	0-1320°C / 1°C Steps	0-1320°C / 1°C Steps
LED display Setpoint value	4 digits	6 digits
LED display Actual value	4 digits	6 digits
Display of units	•	•
Display of firing stages	•	•
Event control	-	For possible configurations please see valid price list
Zone control	-	
Error message	•	•
Safety lock	-	•
Display electricity consumption	-	•
Protection against over-temperature	•	•
Firing chamber monitoring	-	•
Optional printer port	-	•
Programs	5 free	10 free
Segments	2	2
Program delay	0:00 - 9:59 h	0:00 - 9:59 h
1. heating rate	1-999°C / h and Full	1-999°C / h and Full
Switch point	20-1320°C	20-1320°C
1. dwell time	-	0:00 - 9:59 h
2. heating rate	1-999°C / h and Full	1-999°C / h
2. dwell time	0:00 - 9:59 h	0:00 - 9:59 h
Cooling down rate	1-999°C / h and Full	1-999°C / h
Size (w x l x h) / Weight	80 x 153 x 22 mm / 340g	110 x 220 x 60 mm / 450g

Kiln controller TC 88e

Range of application:
Ceramics, laboratory, heat treatment, fusing

High-performance compact control unit with flexible adjustment of programs with up to 15 consecutive segments. Works reliably with highest possible safety in glass, metal and ceramic applications.

- 15 firing programs, freely adjustable
- Delayed start programmable
- Up to 15 segments freely programmable



Kiln controller TC 507

Range of application:
Ceramics, laboratory, heat treatment, fusing

High-performance 30-segment control unit with highest safety standards and many special features. Suitable for demanding workshop and laboratory applications, as well as glass fusing. Equipped with 2- or 3-zone control (optional).

- Up to 30 firing programs, freely adjustable
- Delayed start programmable
- Up to 30 segments freely programmable
- 2 additional switch outputs (optional)

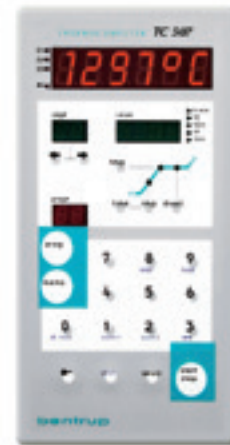

Kiln controllers TC 88e and TC 507

Technical data	TC 88e	TC 507
Control range / Steps	0-1320°C / 1°C Steps	0-1320°C / 1°C Steps
LED display Setpoint value	4 digits	6 digits
LED display Actual value	4 digits	6 digits
Display of units	-	•
Display of firing stages	•	•
Event control	-	For possible configurations please see valid price list
Zone control	-	please see valid price list
Error message	•	•
Safety lock	-	•
Display electricity consumption	-	•
Protection against over-temperature	•	•
Firing chamber monitoring	•	-
Optional printer port	-	•
Programs	15 free	98 free
Segments	15	48
Program delay	0:00-9:59 h	0:00-99:59 h
1. heating rate	20-1320°C / h and Full	1-999°C / h and Full
Switch point	20-1320°C	20-1320°C
1. dwell time	0:00-9:59 h	0:00-99:59 h
2.heating rate	20-1320°C / h and Full	1-999°C / h
2. dwell time	0:00-99:59 h	0:00-99:59 h
Cooling down rate	20-1320°C / h	1-999°C / h
Size (w x l x h) / Weight	65 x 110 x 60 mm / 350 g	110 x 220 x 60 mm / 450g

ROHDE uses controllers from well-known manufacturers only - from standard controllers to individual, customized process solutions.

Panel-mounted compact controller dTRON

- Compact controller can be integrated into the kiln casing, saving space
- Including ramp function, timer start, manual mode
- Configurable user level enables setting of most important parameters
- Individual controller optimisation to adjust to kiln requirements
- Clear presentation of actual and setpoint values



Panel-mounted comfort controller Dicon Touch

- Alphanumeric display saves 10 programs with up to 50 program segments, 2 events (e.g. air supply and exhaust air flap) individually programmable
- Clear presentation of relevant process values
- Integrated paperless recorder, tamper-resistant data storage
- Process data can be collected using USB device or Ethernet connection and exported to the PC using software
- Integrated timer and time switch for program start
- Available as completely attachable controller



Cascade control / Thyristor controller

Cascade control allows continuous kiln power setting, prevents temperature fluctuations and enables precise kiln control. Exact temperature control of ware to be fired allows for implementation of sensitive processes meeting the highest requirements for exact control. Depending on the type of application, the thyristor works as phase angle, burst firing, or amplitude control.

4
8

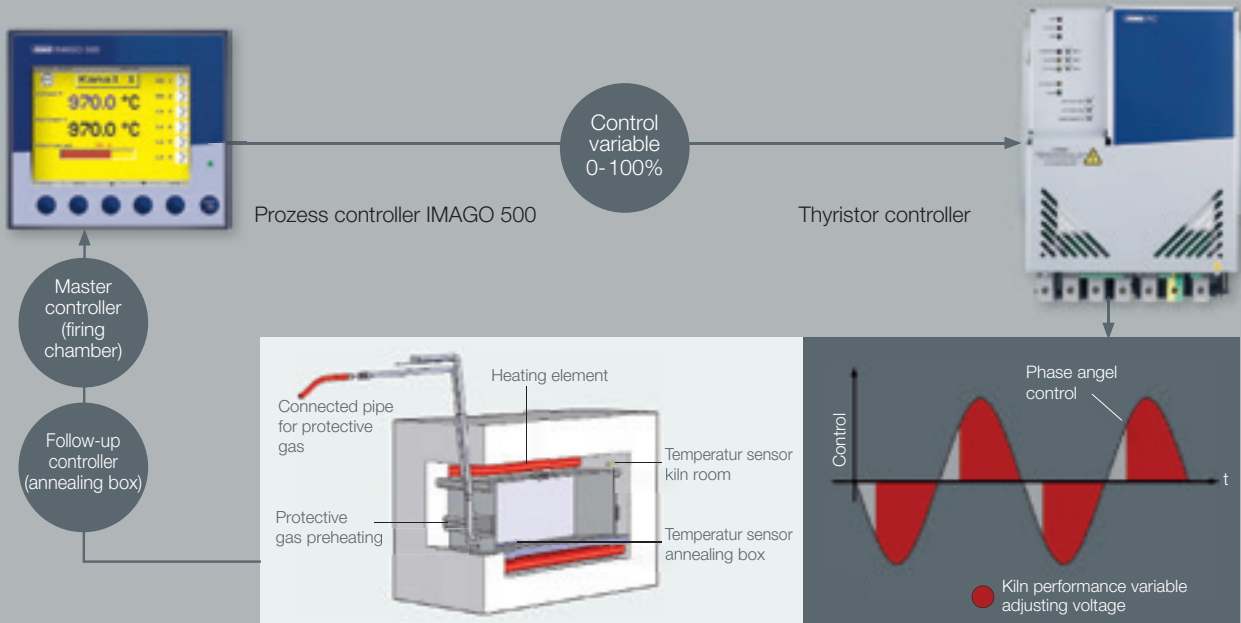

Panel-mounted comfort controller IMAGO 500

- Easy and intuitive to operate, back-lit 5" colour graphic display with multi-channel program and process control with up to 50 programs and 1000 program segments
- Clear presentation of figures, symbols and texts, bargraph display and colours
- Program start programmable using real time clock
- Up to 8 control channels available
- Evaluation of firing curve data on the PC using RJ 45 or RS 485 by PCA user software and PCC communication software



Solutions for network and data storage

Compliance with quality management guidelines often requires documentation of production process values. Data storage systems that are reliable and easy to handle allow these requirements to be met.

Screen recorder LOGOSCREEN nt

- Easy-to-operate rotary knob
- Presents measured values on different diagrams
- Detailed batch reporting
- Including 5.5" TFT colour graphics screen, Ethernet connection and integrated web server
- Evaluation of firing curve data on the PC using RJ 45 or RS 485 by PCA user software and PCC communication software



Professional controller SIEMENS SPS S7-1200 with Panel TP 700 Comfort

- 7" touch screen panel for programming and optimal presentation of program curves
- ROHDE user interface, individually programmable to suit your requirements
- Evaluation of firing curve data on the PC using MS Excel
- Profinet interface for direct network integration, remote control optional

Data storage and SPS control

- Stores process values and firing data (batch denomination, program number etc.) on USB interface
- Saves data in CSV format for further processing with MS Excel



HANDMADE.



ROHDE MACHINERY AND EQUIPMENT



Pottery wheel HMT 500

The HMT 500 has been designed for everyday use in potters' workshops. The high-performance ROHDE machine combines modern control and drive technology with excellent ergonomics that can be integrated into any individual workshop routine.

The outstanding variety of ergonomic settings of wheel and seat guarantee individual working allowing unlimited creativity. The quiet and high-torque drive ensures perfect work procedures even under the highest load. The robust and highly durable ROHDE HMT 500 offers unlimited possibilities.

Special features of the HMT 500:

- Aluminium wheel-head, diameter 340 mm
- Wheel-head equipped with device for quick change MDF wooden batts
- Quiet and powerful high-torque drive, foot pedal for flexible and individual speed adjustment
- Left and right drive
- Working height adjustable from 550 to 690 mm
- Seat adjustable in height, inclination and distance to wheel
- Including large splash pan, easy to remove and with lockable drain outlet



Pan with turntable 340 mm

Working height adjustable
from 550 to 690 mm

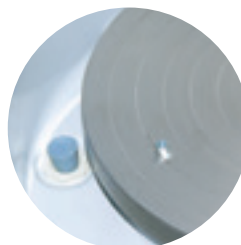

Pottery wheel HMT 500

Model	Ext. dimensions mm			Output W	Voltage V	Supply A	Speed rpm	Weight incl. seat kg
	W	D	H					
HMT 500	530	1200	550	370	230	2	0-250	46

Pugmill TS 20

The ROHDE Pugmill TS 20 stands for robust, durable construction and excellent performance. The machine is highly suitable for kneading of ceramic bodies prior to further processing, mixing of different bodies and preparation of waste clay. The pugmill enables very good preparation of plastic mixes and gives them a high degree of workability for further processing.

The mixing barrel, mixing shaft fitted with wing blades and all other machine components that come into contact with clay are made of stainless steel. The vertical design and the large feeder allow easy top loading of the TS 20. A split body for disassembly facilitates easy cleaning. Two castors and two fixed machine feet guarantee mobility and a firm stand. The tray unit and cutting device are detachable; the aluminium nozzle is fitted with threads to fix extruder dies.

Special features of the TS 20:

- Large stainless steel mixing barrel (diameter 235 mm)
- Aluminium die (diameter 80 mm) with plastic lining
- Clay throughput up to 600 kg/hour
- Split barrel facilitates easy and safe cleaning
- Working table fitted with device to divide into portions
- Safety unit for automatic switch-off



Barrel, shaft and blades made of stainless steel

Outstanding clay preparation



Pugmill TS 20

Model	Ext. dimensions mm			Output kW	Voltage V	Supply A	Speed rpm	Weight kg
	W	D	H					
TS 20 / 400 V	540	1100	1070	1,1	400	3,0	15	105
TS 20 / 230 V	540	1100	1070	1,1	230	7,2	15	105

Slab roller PW 600

The ROHDE Slab roller PW 600 is a very robust and high-quality machine for rolling plastic ceramic bodies and is extremely easy and safe to handle.

The PW 600 frame construction is made of strong, high-quality welded square tubes that provide the highest resistance to distortion. The four fixable plug-in feet can be disassembled for transport allowing it also to be used as a tabletop slab roller.

The clay body is fed in between two sturdy linen cloths for rolling. The large roller diameter and the smooth-running wheel handle allow the slab to be fed easily through rollers across the entire workspace. The thickness indicator allows the thickness of the slab to be precisely and continually adjusted from two sides. Guided by high-quality grooved ball bearings, the roller slide runs over a smooth, stainless steel roller table. This ensures the highest precision in everyday use in workshops and schools.

Clay slabs can be removed from the slab roller without effort and are then ready for further processing. The ROHDE PW 600 does not require elaborate cleaning.

Special features of the PW 600:

- Large workspace (650 x 850 mm) providing good overview
- Continuous setting of thickness (up to 85 mm) from two sides, easy-to-read scale
- Precise movement of roller using 8 ball bearings on stainless steel roller table
- 2-layer industrial linen cloth, easy cleaning
- Roller diameter 100 mm
- Large wheel handle facilitates operation

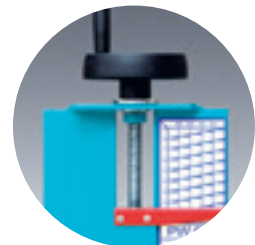

Slab roller PW 600

Model	Usable dimensions mm			Ext. dimensions mm			Weight
	w	d	h	W	D	H	kg
PW 600	650	850	0-85	880	1410	1250	100

Spray booth SK 66

The ROHDE Spray booth SK 66 has been specially designed for applications in the ceramic manufacturing process. It prevents fine glaze and colour particles from escaping into the air and guarantees dust-free and safe working in the entire workshop.

The SK 66 is outstanding in its sturdy and functional assembly. The corrosion-free booth made of shockproof plastic material ensures the particularly silent, smooth and high-performance operation of this unit.

The ROHDE filter system is integrated into the exhaust device and can be easily cleaned or changed without using tools and prevents toxic colour and glaze particles from escaping into the air. The SK 66 guarantees high safety, excellent ergonomics, low noise levels at high performance level and can be easily accessed for cleaning.

Special features of the SK 66:

- Booth made from 8 mm shockproof polypropylene plastics, no corrosion
- Filter integrated in rear wall, easy to remove and wash
- Easy clean-up of machine
- Vacuum fan, silent and powerful

Optional accessories:

- Piece for reduction, diameter 150 mm
- Turntable (banding wheels)



Powerful fan allowing for high air movement

Both stand steel constructed, galvanised and lacquered, easy to fit



Spray booth SK 66

Model	Usable dimensions mm			Ext. dimensions mm			Weight kg	Fan			
	w	d	h	W	D	H		V	W	Hz	Volume flow
SK 66	670	520	750	790	790	1700	42	230	330	50	1540 m³/h

Banding wheels RSN/RSH and RSSN/RSSH

ROHDE Banding wheels are professional appliances that are extremely versatile in the ceramic manufacturing process. They are characterised by a particularly high quality standard and allow the flexibility that is required for the precise processing of a workpiece.

All ROHDE Banding wheel models stand for high-quality workmanship, durability and smooth and silent rotation. The turntable surface is grooved with concentric circles for centring which enables precise positioning of the workpiece. The turntables of models RSN and RSH rotate on a minimal contact point on a hardened steel ball resulting in a remarkably long rotation time. Both models can be locked at any position with a set screw.

The two larger models RSSN and RSSH are made of high-quality grey cast iron that guarantees remarkable robustness allowing the processing of pieces up to 100 kilos. The turntables of the models RSSN and RSSH rotate on two grooved ball bearings which results in a particularly smooth and long rotation time allowing for precise treatment of the workpieces.

Special features of Banding wheels:

- Precise workmanship and high-quality lacquering
- Smooth, silent rotation
- Models RSN and RSH can be fixed with wing screw
- Models RSN and RSH with turntable diameter 220 mm
- Models RSSN and RSSH with turntable diameter 260 mm
- Turntable grooved with concentric circles for centring

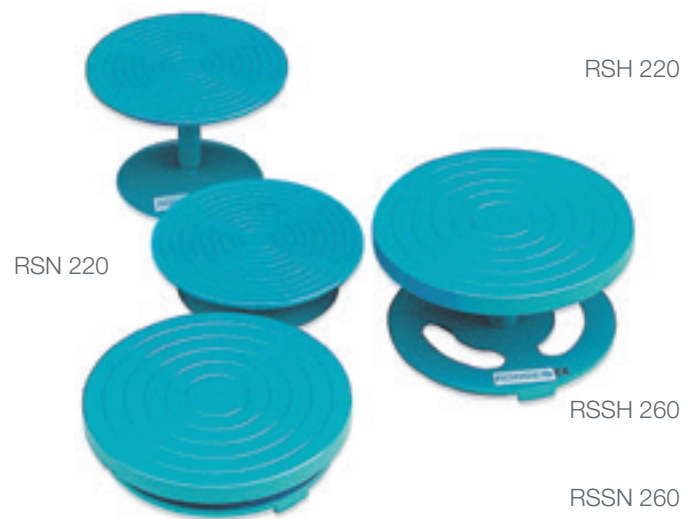

Banding wheels RSN / RSH and RSSN / RSSH

Model	Height	Diameter	Weight
	mm	mm	kg
RSN 220 lackiert	60	220	3,0
RSH 220 lackiert	155	220	3,5
RSSN 260 lackiert	60	260	6,0
RSSH 260 lackiert	140	260	7,0

Banding wheels for standing operation SRS und SRS H

ROHDE Banding wheels for standing operation are all-purpose tools for professional use in ceramic workshops and are available for the first time on the European market. The banding wheels can be adjusted in height and are very heavy, which gives them an outstanding stability.

The turntable rotates on a ball bearing resulting in a remarkably long and smooth rotation time. It is possible to lock the turntable in any position with a set screw and to adjust its height continuously ensuring ergonomic working.

ROHDE Banding wheels for standing operation can be used for a variety of applications. They facilitate many work processes that require high precision and concentration such as sculpting, carving or decorating of ceramics. Benefit from this robust and durable appliance and enjoy your results.

Special features of Banding wheels for standing operation:

- Solid and stable
- Continuous height adjustment
- Turntable can be locked
- Cast iron leg gives stability
- Turntable diameter 220 or 280 mm
- Height adjustment section SRS 220 / 280: 650 - 950 mm
- Height adjustment section SRS 220 H / 280 H: 1000 - 1300 mm

Ergonomic fixing handle allows for continuous height adjustment

Turntable rotates precisely on ball bearing resulting in smooth rotation



Banding wheels for standing operations **SRS** and **SRS H**

Model	Height	Diameter	Weight
	mm	mm	kg
SRS 220	650-950	220	15
SRS 220 H	1000-1300	220	16
SRS 280	650-950	280	16
SRS 280 H	1000-1300	280	17

Sedimentation Basin AB 100

The ROHDE Sedimentation basin AB 100 is the ideal support for environmental awareness in the ceramic workshop. Glazes, clays and engobes are effectively collected and removed from the wastewater before they reach the sewage system.

This appliance can be connected to practically any drain allowing for flexible use. It is delivered with a siphon and inlet socket, a cover is optionally available. The stable and shockproof basin made of environmentally sound polypropylene plastic is highly flexible due to a supporting steel construction mounted on 4 mobile castors.

The tank has a generous three-compartment system that prevents the blockage of pipes and leads to a reduction in environmental stress. After cleaning using a ROHDE Sedimentation basin, wastewater complies with local regulations for wastewater.

Special features of the AB 100:

- Generous three-compartment system
- Environmentally sound polypropylene plastic tank, stable and shockproof
- Variable connection of inlet socket (diameter 40 mm)
- 4 mobile castors
- Optional cover



Solid castors allow comfortable and safe handling

Can be mounted to practically any sink and washbasin



Sedimentation basin AB 100

Model	Usable dimensions mm			Ext. dimensions mm			Weight
	w	d	h	W	D	H	
AB 100	425	610	415	450	630	520	13

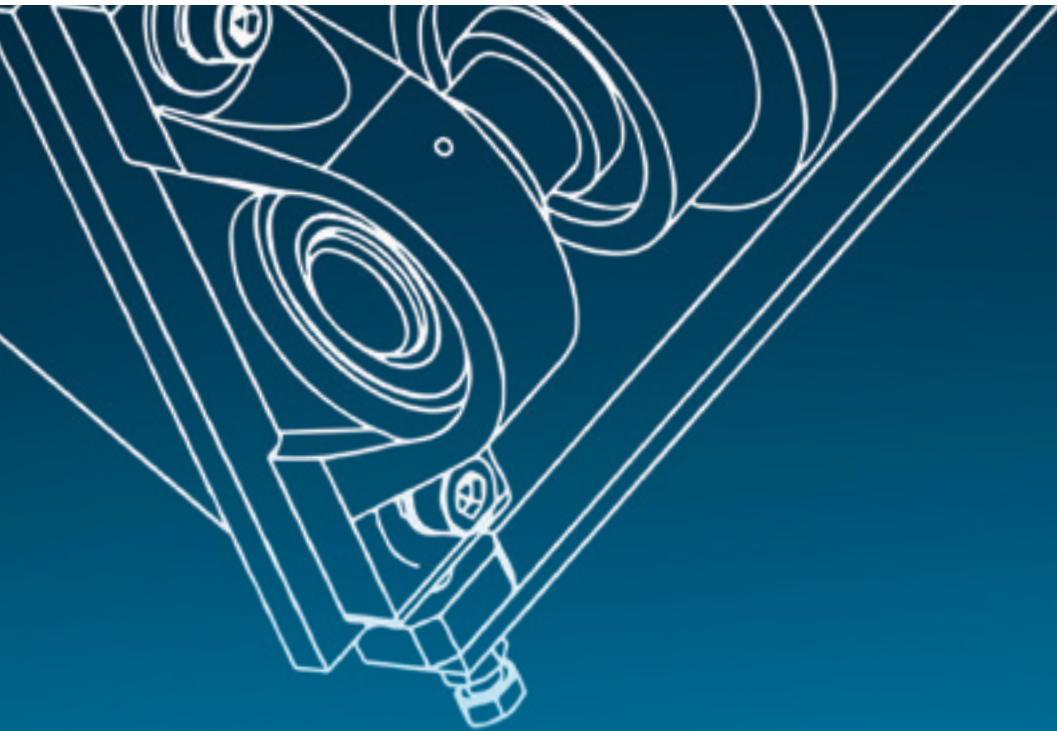

MISSION **POSSIBLE.**



Anything is possible. ROHDE provides the best solution for you either from its wide range of products or with a special customised construction, all offering maximum efficiency and completely to your advantage. Contact ROHDE and see for yourself.

ROHDE kilns, controllers and machinery for heat treatment of ceramics and glass in manual or industrial applications are based on proven, sophisticated technologies. ROHDE quality is ensured by safety and quality testing with seals of approval, CE certifications, SEV conformity, GS marks as well as unique patents and guarantee perfect firing and working results.

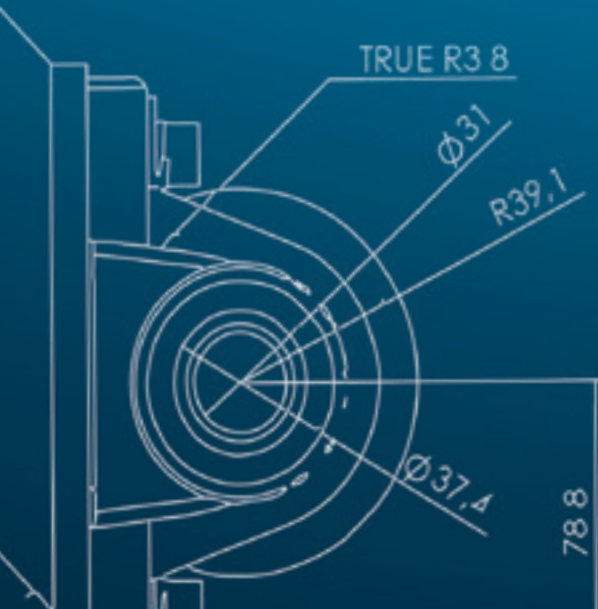

Delivery to a basement, second floor or through a window?

The ROHDE delivery service

ROHDE provides inexpensive, easy and safe delivery and set-up assistance for ROHDE kilns from a single source. The ROHDE delivery service provides safe on-site delivery of your kiln, including on-site instruction and initial operation by ROHDE experts if required. Full insurance from start to finish. Talk with ROHDE about your operating location.

Warranty and spare part service

ROHDE guarantees 3-year warranty (not on heating elements) on almost any ROHDE kiln and thermocouples. ROHDE and your local retailer are there for you when service is required.

ROHDE assures unlimited supply of spare parts. Spare parts are usually ready for dispatch one workday after receipt of order.

ROHDE always uses environmentally friendly materials and guarantees acceptance of each ROHDE product for recycling of reusable parts or environmentally sound disposal.

ROHDE is there for you

ROHDE is committed to personal service. Contact ROHDE by email or phone, whatever your needs. ROHDE employees are pleased to assist you at any time.



Delivery and set-up service



On-site instruction and initial operation



3-year warranty



Spare parts and service



Environmentally sound materials and recycling



COMMITTED TO **SERVICE.**





Enjoy your results.



For more information, please
contact your local retailer, visit
the homepage or contact
ROHDE directly.



Direct contact using
smartphone

ROHDE

Helmut ROHDE GmbH
Ried 9
83134 Prutting, Germany
Phone +49 8036 674976-10
Fax +49 8036 674976-19
info@rohde-online.net
www.rohde-online.net

Technical and dimensional modifications
subject to change without notice.