



| Industry

Enjoy your **results.**

2017/18 PRODUCT CATALOGUE  
FURNACES AND SYSTEMS

for heat treatment

WELCOME TO ROHDE

QUALITY

SAFETY

EFFICIENCY

PASSION

CHAMBER FURNACES

About ROHDE	4–9
Chamber Furnaces	10–11
Chamber Furnaces KE series	12–13
Ergo Load System ELS series	14–15
Annealing and Hardening Furnaces ME series	16–17
Laboratory Furnaces LS series	18–19
Air Circulating Chamber Furnaces KU series	20–21
Dewaxing Chamber Furnaces	22–23
Debinding Chamber Furnaces	24–25

TRUCK FURNACES

Truck Furnaces	26–27
Electric Truck Furnaces HWE series	28–29
Air Circulating Truck Furnaces HWU series	30–31
Gas-fired Truck Furnaces HWG series	32–33

HOOD FURNACES

Hood Furnaces	34–35
Hood Furnaces HE series	36–37

TOPLOADERS

Toploaders	38–39
Regeneration Furnaces TE-DPF series	40
Shaft Furnaces BT series	41

EXHAUST AIR CLEANING

Exhaust Air Cleaning	42–43
Catalytic Post-Combustion CPC	44
Thermal Post-Combustion TPC	45

MEASURING AND CONTROL TECHNOLOGY

Measuring and Control Technology	46–47
Control Systems	48–49
Control Technology	50–51

REFERENCES

References	52
Custom-designed Chamber Furnaces	54–57
Custom-designed Truck Furnaces	58–61
Custom-designed Hood Furnaces	62–65
Custom-designed Toploaders	66–69

Service and Contact	70–72
---------------------	-------

Since the company was founded in 1982, ROHDE has been committed to customer and product benefits and offers solutions in all areas of heat treatment. Benefit from smooth processes and efficient workflows when it comes to the consultation as well as the development, construction and manufacture of your furnace.

## INNOVATIVE BY TRADITION – TODAY, TOMORROW AND IN THE FUTURE

Our extensive product range comprising standard furnaces provides well-engineered models that suit almost any of your applications and are available at short notice. The wide range of products and varied options allow for specially adapting each standard furnace to your process.

ROHDE has a competent team for the development of special heat treatment solutions if our standard products do not suit your process. Individual heat treatment solutions are designed in collaboration with the customer. On request, our technicians install and commission them on site.

This means that we can always find the perfect solution.



“WE ARE COMMITTED TO  
OFFERING A TECHNOLOGICAL  
AND QUALITATIVE LEADING EDGE.”



## INDUSTRY

ROHDE technology stands for excellent production results in industrial heat treatment.

When it comes to calcining, debinding, annealing and hardening. Nitriding, tempering, quenching and other thermal processes. Testing, preheating, firing and sintering in laboratory applications or melting, incinerating and drying.

ROHDE provides solutions for a wide spectrum of applications.

ROHDE SOLUTIONS –  
ALWAYS **RELIABLE** AND **EFFICIENT**.



## ARTS AND CRAFTS

As a ceramic or glass artisan, you combine creativity, art and technology. Your work is an expression of your inspiration and skills. The final firing process is decisive when it comes to completing your work.

ROHDE kilns and furnaces: because the moment you open the furnace and see the fruit of your labours in perfection is always a very special moment for you.



## MATERIALS

Metal  
 Ceramics  
 Glass  
 Plastics  
 Composite materials

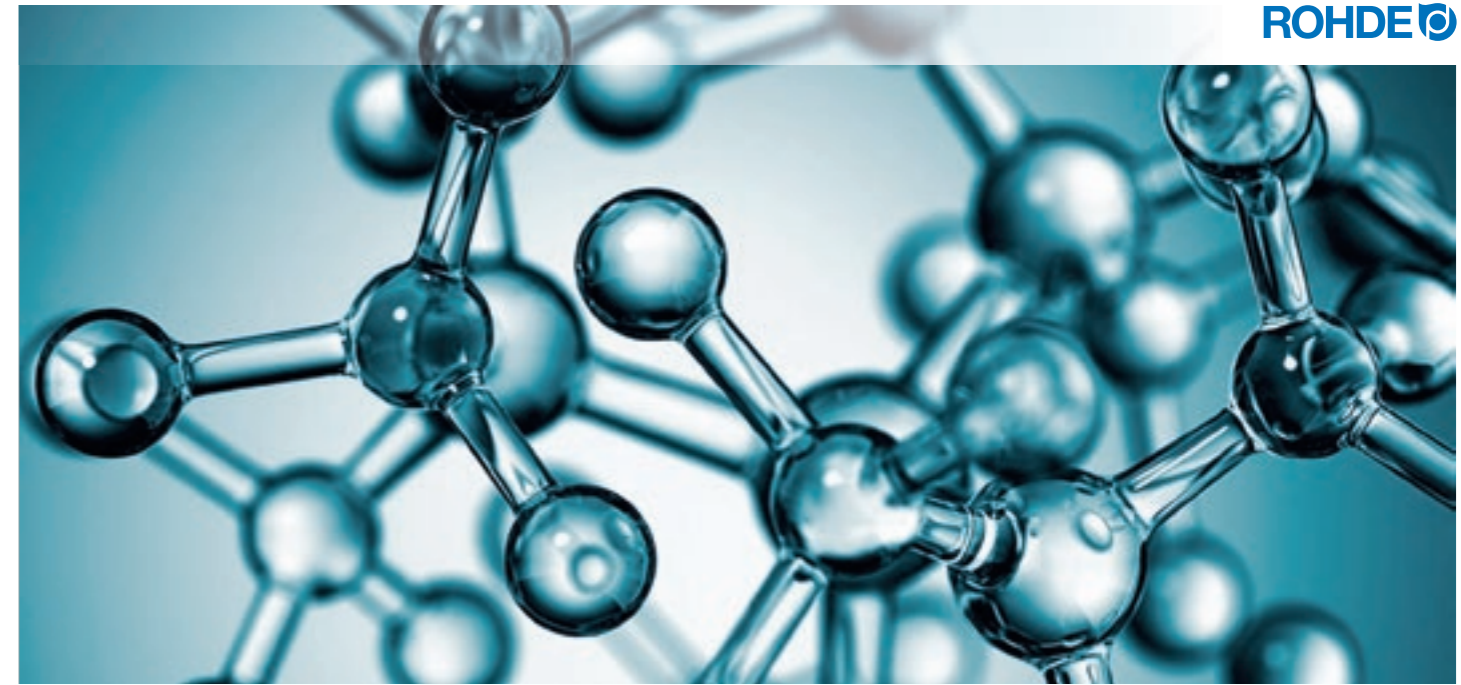

## INDUSTRIES

Coal and steel industry	Shipbuilding
Foundries	Abrasives
Mechanical and plant engineering	Optical industry
Model and mould-making	Chemical industry
Ceramics	Pharmaceutical industry
Glass processing	Dental industry
Automotive sector	Research & laboratories
Aerospace industry	Educational institutions



## APPLICATIONS

Preheating and heating	Debinding
Drying	Sintering
Bending	Aging
Tempering	Incinerating
Annealing and hardening	Coating removal
Quenching	Evaporating
Carburizing	Hardening
Calcining	Firing
Tempering	Melting

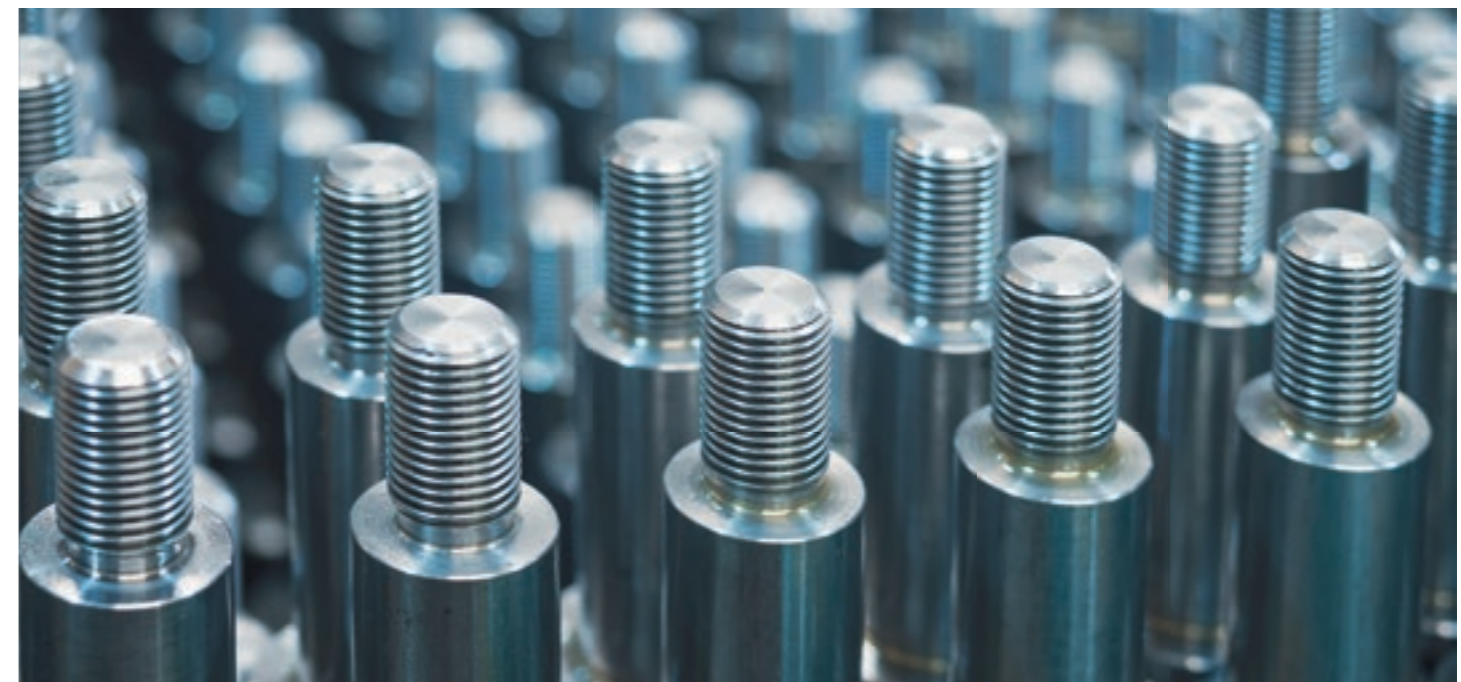

# ROHDE **CHAMBER FURNACES**

THE **TREASURE CHAMBER**  
OF YOUR PRODUCTS.



**Chamber Furnaces KE series**

ROHDE Chamber Furnaces from the KE series comprise models with furnace volumes between 100 and 1000 litres and are suitable for temperature ranges up to 1200°C, 1300°C and 1400°C.

The reliable all-rounder for heat treatment has been especially designed for many years of continuous use in production and manufacturing.

The torsion-resistant steel construction, high-quality insulation material and 5-side heating provides even distribution of heat throughout every performance range. KANTHAL heating elements have been calculated with minimal surface load to minimise wear and to ensure a long service life.

ROHDE develops customised special solutions to meet the respective application requirements with individual dimensions and varied optional equipment.

- ⊙ 5-side heating
- ⊕ Heating elements recessed into bricks (KE /12)  
Heating elements mounted on support rods (KE/13 and KE /14)
- ⊓ 3-layer insulation structure
- ☆ Robust R-SiC ceiling support



KE 200/12



KE 200/13



KE 100/14

“System ROHDE” R-SiC ceiling support prevents cracks and particles falling onto the products

Corrosion protection and low external temperature due to in-frame ventilation



**Electric Chamber Furnaces KE series to 1400°C**

Model	Volume	T <sub>max</sub> °C	Internal dimensions mm			External dimensions mm			Output kW	Supply A	Connector Plug	Voltage V	Weight kg
			b	t	h	B	T	H					
KE 100/12	100	1200	410	480	530	750	1050	1700	6,6	10	CEE 16 A	400 V/50 Hz	323
KE 200/12	200	1200	460	640	680	800	1210	1780	11,0	16	CEE 16 A	400 V/50 Hz	415
KE 330/12	330	1200	590	720	790	920	1280	1800	16,5	25	CEE 32 A	400 V/50 Hz	531
KE 480/12	480	1200	640	770	980	980	1340	1830	22,0	32	CEE 32 A	400 V/50 Hz	641
KE 100/13	100	1300	460	470	540	750	1040	1700	8,0	12	CEE 16 A	400 V/50 Hz	324
KE 200/13	200	1300	590	630	680	800	1210	1770	13,2	20	CEE 32 A	400 V/50 Hz	416
KE 330/13	330	1300	640	720	800	930	1280	1800	22,0	32	CEE 32 A	400 V/50 Hz	529
KE 480/13	480	1300	720	770	1020	980	1340	1830	32,0	47	CEE 63 A	400 V/50 Hz	630
KE 750/13	750	1300	920	1100	1030	1570	1690	2010	50,0	73	-	400 V/50 Hz	1122
KE 1000/13	1000	1300	410	1070	1140	1660	1610	2040	70,0	100	-	400 V/50 Hz	1250
KE 100/14	100	1400	580	480	530	810	1120	1700	10,5	16	CEE 16 A	400 V/50 Hz	403
KE 200/14	200	1400	630	640	680	890	1280	1790	18,0	26	CEE 32 A	400 V/50 Hz	558
KE 330/14	330	1400	580	710	800	1080	1350	1840	32,0	47	CEE 63 A	400 V/50 Hz	690
KE 480/14	480	1400	630	770	995	1130	1410	1860	40,0	59	CEE 63 A	400 V/50 Hz	800

**Optional accessories for Chamber Furnaces KE series**



Automatic exhaust air flaps



Automatic air supply and exhaust air flaps



Active cooling system

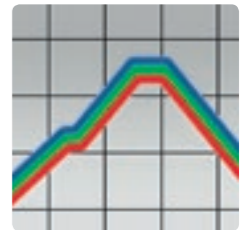

Multi-zone control



Stainless steel exhaust air hood



Door opening to the left



Forklift charging car



Individual measuring and control technology

**Chamber Furnaces Ergo Load System  
ELS series**

ROHDE Chamber Furnaces with the Ergo Load System from the ELS series comprise models with furnace volumes between 150 and 1000 litres and are suitable for temperature ranges up to 1200°C and 1300°C.

Based on the design of chamber furnaces, ROHDE has developed the unique ELS Ergo Load System furnace concept. The free-running mechanism of this furnace allows the floor to be pulled out completely.

The furnace floor can be pulled out effortlessly using the door that opens to 180° and allows charging on three sides. This makes it faster, safer and more efficient to load the furnace, combining the compact chamber furnace construction with all the advantages of truck furnace loading.

The entire steel construction is equipped with an in-frame ventilation made of stainless steel sheets contributing to low external temperatures and the best possible corrosion protection. The insulation comprises three layers and the furnace floor is fitted with a conical sealing cord providing optimum sealing.

- Ⓞ 5-side heating
- Ⓜ Heating elements recessed into bricks (ELS /12)  
Heating elements on support rods (ELS /13)
- Ⓜ 3-layer insulation structure
- Ⓢ ELS Ergo Load System

Easy charging on three sides  
when the furnace floor is pulled out

Silent, low-wear solid-state relays  
with external cooling element



ELS 200/12



ELS 200/13



ELS 480/13



**Optional accessories** for Chamber Furnaces ELS series



Automatic exhaust  
air flaps



Automatic air supply  
and exhaust air flaps



Active cooling system

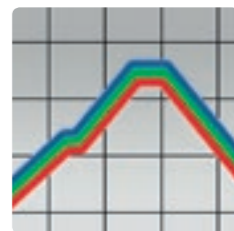

Multi-zone control



Stainless steel  
exhaust air hood



Door opening to the left



Electrically extendable  
furnace floor



Individual measuring  
and control technology

Electric Chamber Furnaces **ELS** series to 1300°C

Model	Volume	T <sub>max</sub> °C	Internal dimensions mm			External dimensions mm			Output kW	Supply A	Connector Plug	Voltage V	Weight kg
			b	t	h	B	T	H					
ELS 150/12	150	1200	460	460	680	800	1080	1730	9,0	13	CEE 16 A	400 V/50 Hz	450
ELS 200/12	200	1200	460	620	680	800	1240	1730	11,0	16	CEE 16 A	400 V/50 Hz	510
ELS 150/13	150	1300	460	460	680	800	1080	1730	10,5	16	CEE 16 A	400 V/50 Hz	460
ELS 200/13	200	1300	460	620	680	800	1250	1670	13,2	20	CEE 32 A	400 V/50 Hz	550
ELS 330/13	330	1300	590	720	800	930	1310	1840	22,0	32	CEE 32 A	400 V/50 Hz	690
ELS 480/13	480	1300	640	770	995	1060	1420	1970	32,0	47	CEE 63 A	400 V/50 Hz	800
ELS 750/13	750	1300	720	1110	1030	1510	1730	1970	50,0	73	-	400 V/50 Hz	1350
ELS 1000/13	1000	1300	920	1060	1145	1670	1730	2100	70,0	100	-	400 V/50 Hz	1500



**Annealing and Hardening Furnaces ME series**

ROHDE Annealing and Hardening Furnaces from the ME series comprise models with furnace volumes between 10 and 665 litres and are suitable for temperatures up to 1300°C.

The reliable all-rounder for heat treatment of metals, has been designed for many years of use in tough production and workshop operations.

The torsion-resistant steel construction, high-quality insulation material and particularly durable firebricks in the door area meet the highest requirements for quality and reliability. The parallel swing door reduces heat radiation and allows easy and safe operation.

3-side heating with heating elements mounted on support rods provides even distribution of heat. KANTHAL heating elements have been calculated with minimal surface load to minimise wear and to ensure a long service life.

- ☉ 3-side heating
- ☼ Heating elements on support rods
- ☼ 2-layer insulation structure
- ☼ Solid construction, entirely in-frame ventilated



ME 10/13



ME 45/13



ME 105/13

Smooth and easy door mechanism for safe and effortless opening of the furnace when hot

Corrosion protection and low external temperature due to in-frame ventilation



Annealing and Hardening Furnaces **ME** series to 1300°C

Model	Volume	T <sub>max</sub> °C	Internal dimensions mm			External dimensions mm			Output kW	Supply A	Connector Plug	Voltage V	Weight kg
			b	t	h	B	T	H					
ME 10/13	10	1300	250	250	120	500	600	700	2,5	13	Schuko	230 V/50 Hz	69
ME 15/13	15	1300	250	250	200	500	700	700	3,6	16	Schuko	230 V/50 Hz	75
ME 20/13	20	1300	250	350	200	500	700	700	6,0	16	CEE 16 A	400 V/50 Hz	91
ME 30/13	30	1300	250	500	200	500	850	700	7,0	16	CEE 16 A	400 V/50 Hz	105
ME 45/13	45	1300	350	500	250	1000	1300	1400	13,0	19	CEE 32 A	400 V/50 Hz	268
ME 65/13	65	1300	350	750	250	1000	1400	1400	20,0	29	CEE 32 A	400 V/50 Hz	330
ME 87/13	87	1300	350	1000	250	1000	2000	1400	22,0	32	CEE 32 A	400 V/50 Hz	280
ME 105/13	105	1300	500	750	300	1350	1850	1900	22,0	32	-	400 V/50 Hz	636
ME 165/13	165	1300	550	750	400	1400	1850	2000	30,0	44	-	400 V/50 Hz	900
ME 333/13	333	1300	750	1100	400	1600	2200	2000	44,0	64	-	400 V/50 Hz	1445
ME 665/13	665	1300	1000	1300	500	1850	2400	2100	70,0	100	-	400 V/50 Hz	2600

**Optional accessories** for Annealing and Hardening furnaces ME series

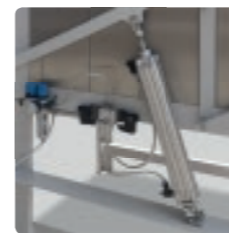

Pneumatic door opening



Semi gas-tight construction with protective gas connection

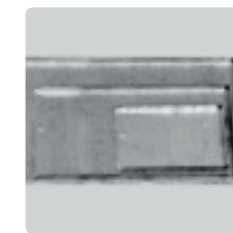

Robust charging plates



Active cooling system



SiC cover for heating elements



Different hardening units



Hardening boxes



Hardening boxes with protective gas connection

**Laboratory Furnaces LS series**

ROHDE Laboratory Furnaces from the LS series comprise models with furnace volumes between 15 and 120 litres and are suitable for temperature ranges up to 1300°C and 1400°C.

The furnace series has been developed especially to meet the various requirements in laboratory and production applications. Its cubic useful volume is ideally suitable for testing, inspecting, preheating, firing, sintering, melting and incinerating.

The torsion-resistant steel construction, high-quality insulation material and 5-side heating with heating elements mounted on support rods provide the best possible distribution of heat. KANTHAL heating elements have been calculated with minimal surface load to minimise wear and to ensure a long service life.

Extensive accessories such as air supply and exhaust air flap control, an active cooling system or a parallel swing door allow the furnace to meet your individual requirements.

- ⊙ 5-side heating
- ⊞ Heating elements on support rods
- ⊞ 3-layer insulation structure
- ☆ Solid construction, entirely in-frame ventilated



LS 30/13



LS 60/14

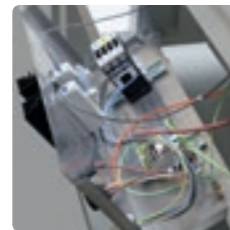

Easy-to-maintain switchgear at the back of the furnace, easily accessible

5-side heating provides rapid heating rates with even distribution of heat

Laboratory Furnaces **LS** series to 1400°C

Model	Volume	T <sub>max</sub> °C	Internal dimensions mm			External dimensions mm			Output kW	Supply A	Connector Plug	Voltage V	Weight kg
			b	t	h	B	T	H					
LS	15/13	1300	250	250	250	650	800	1400	7,0	16	CEE 16 A	400 V/50 Hz	160
LS	30/13	1300	320	320	320	700	850	1450	8,0	12	CEE 16 A	400 V/50 Hz	190
LS	60/13	1300	400	400	400	780	950	1520	11,0	16	CEE 16 A	400 V/50 Hz	250
LS	120/13	1300	500	500	500	880	1050	1620	15,0	22	CEE 32 A	400 V/50 Hz	300
LS	15/14	1400	250	250	250	700	850	1400	8,0	18	CEE 32 A	400 V/50 Hz	250
LS	30/14	1400	320	320	320	780	900	1450	10,0	15	CEE 16 A	400 V/50 Hz	330
LS	60/14	1400	400	400	400	860	970	1520	12,0	18	CEE 32 A	400 V/50 Hz	365
LS	120/14	1400	500	500	500	960	1080	1620	18,0	26	CEE 32 A	400 V/50 Hz	470

**Optional accessories** for Laboratory Furnaces LS series



Parallel swing door



Semi gas-tight construction with protective gas connection



Automatic exhaust air flaps



Automatic air supply and exhaust air flaps



Active cooling system



Individual measuring and control technology

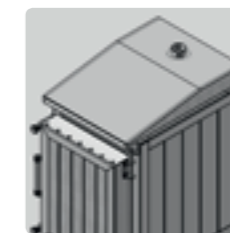

Stainless steel exhaust air hood



Port to mount additional thermocouples

**Air Circulating Chamber Furnaces KU series**

ROHDE Air Circulating Furnaces from the KU series comprise models with furnace volumes between 15 and 800 litres and temperature ranges up to 650°C and 750°C.

This model is suitable for a variety of materials and applications and is used for tempering, aging, preheating, drying, shrinking, curing and testing for instance.

The robust housing construction consists of high-quality steel sheets. The internal housing is made of heat-resistant stainless steel guaranteeing a long service life and is extremely durable and corrosion-resistant. The high-quality insulation ensures efficient use of energy and contributes to reduced electricity costs and low external temperatures.

One of the principal characteristics of this series is the even distribution of temperature, achieved through heating from several sides and powerful air circulation. These furnaces can be equipped with inserting shelves and two fitted inserting trays to allow the best utilisation of the interior.

- ☉ 2-side heating with powerful air circulation
- ☹ Tubular heating elements
- ☹ 2-layer insulation structure
- ☼ High temperature accuracy



KU 15/65



KU 40/65

Powerful air circulation results in even temperature distribution  
The dTron 304 program controller allows easy and intuitive operation



**Air Circulating Chamber Furnaces KU series to 750°C**

Model	Volume	T <sub>max</sub> °C	Internal dimensions mm			External dimensions mm			Output kW	Supply A	Connector Plug	Voltage V	Weight kg
			b	t	h	B	T	H					
KU 15/65	15	650	300	350	150	505	890	445	2,4		230 V/50 Hz	75	
KU 40/65	40	650	300	400	300	665	1075	1315	4,0		400 V/50 Hz	235	
KU 70/65	70	650	350	500	400	715	1175	1415	8,0		400 V/50 Hz	250	
KU 140/65	140	650	450	600	500	815	1275	1515	12,0		400 V/50 Hz	330	
KU 270/65	270	650	600	750	600	965	1600	1685	16,0		400 V/50 Hz	500	
KU 540/65	540	650	750	900	800	1115	1750	1885	24,0		400 V/50 Hz	650	
KU 800/65	800	650	800	1250	800	1665	2100	1885	35,0		400 V/50 Hz	895	
KU 40/75	40	750	300	400	300	715	1165	1450	5,2		400 V/50 Hz	240	
KU 70/75	70	750	350	500	400	765	1265	1550	10,4		400 V/50 Hz	270	
KU 140/75	140	750	450	600	500	865	1365	1650	14,0		400 V/50 Hz	390	
KU 270/75	270	750	600	750	600	1090	1725	1805	21,0		400 V/50 Hz	690	
KU 540/75	540	750	750	900	800	1240	1875	2005	28,0		400 V/50 Hz	800	
KU 800/75	800	750	800	1250	800	1290	2225	2005	40,0		400 V/50 Hz	1105	

**Optional accessories for Air Circulating Furnaces KU series**

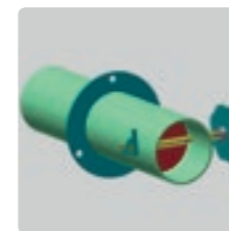

Exhaust air flaps



Active cooling system



Pneumatic lifting door



Protective gas retort



Inserting trays

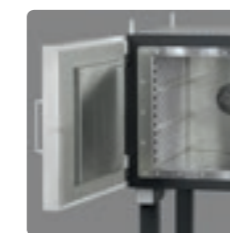

Door opening to the left



Base frame on castors



Individual measuring and control technology

**Dewaxing Chamber Furnaces KE-EW series**

ROHDE Dewaxing Chamber Furnaces from the KE-EW series comprise models with furnace volumes between 6 and 600 litres and are suitable for temperature ranges up to 1000°C.

The series has been designed to burn-out wax and plastic moulded parts using controlled exchange of air. It combines all relevant functions in one furnace: melting, clean combustion of the moulding material and the firing of moulds.

Furnaces from KE 150/10 EW upwards use the precise supply of pre-heated air to ensure even drying and heating of casting moulds thus reducing the risk of cracking of the mould. Good heat distribution throughout the dewaxing process shortens the firing process and allows efficient energy supply.

Exact control of the dewaxing process step prevents moulding material from uncontrolled ignition and at the same time allows reliable escape of exhaust gases. A special supporting grid is combined with a practical collecting drawer positioned below the furnace allowing the moulding material to be easily collected and emptied.

- ☉ 2-side heating (KE 6/10 EW - KE 50/10 EW)  
4-side heating (from KE 150/10 EW upwards)
- ☼ Heating elements recessed into bricks
- ☼ 2-layer insulation structure
- ☼ All relevant functions combined in one system

High-quality control system for clear presentation of process data (from KE 150 EW upwards)

Moulding material easy to collect and empty using practical collecting drawer



KE 50/10 EW



KE 150/10 EW

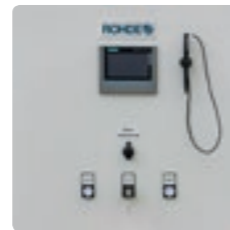

Dewaxing Chamber Furnaces **KE-EW** series to 1000°C

Model	Volume	T <sub>max</sub> °C	Internal dimensions mm			External dimensions mm			Output kW	Supply A	Connector Plug	Voltage V	Weight kg
			b	t	h	B	T	H					
KE 6/10 EW	6	1000	180	170	220	380	550	780	1,8	8	Schuko	230 V/50 Hz	45
KE 14/10 EW	14	1000	250	250	250	450	600	800	2,3	10	Schuko	230 V/50 Hz	55
KE 20/10 EW	20	1000	300	300	200	530	670	750	3	13	Schuko	230 V/50 Hz	60
KE 50/10 EW	50	1000	300	450	315	520	840	865	5	11	CEE 16 A	400 V/50 Hz	90
KE 150/10 EW	150	1000	460	470	580	800	1100	1800	13,5	20	CEE 32 A	400 V/50 Hz	460
KE 330/10 EW	330	1000	590	720	700	1000	1350	2100	22	32	CEE 32 A	400 V/50 Hz	680
KE 600/10 EW	600	1000	710	870	920	1100	1500	2300	40	59	CEE 63 A	400 V/50 Hz	1000

**Features** of the Dewaxing Chamber Furnaces KE-EW series



Automatic process flow



Air preheating for controlled burning-off



Integrated collecting drawer for moulding material



Removal of noxious gases through a separate flue system

**Debinding Chamber Furnaces KE-DB series**

ROHDE Debinding-Sintering Chamber Furnaces from the KE-DB series comprise models with furnace volumes between 200 and 1000 litres and are suitable for temperature ranges up to 1300°C and 1400°C.

Many components and in particular components made of technical ceramics require continuous treatment using a debinding and sintering process in one furnace system. ROHDE has developed the KE-DB series from the proven chamber furnaces to meet these particular requirements.

These combination furnaces are equipped with a flushing air preheating unit i.e. specific flushing of the furnace interior with preheated air during debinding. As a result, good temperature distribution is obtained inside the furnace and reliable removal and discharge of binders from the firing chamber are achieved.

After debinding is completed, the flushing air preheating turns off and starts the sintering process right away, thus saving time and elaborate handling between the two processes.

- ☉ 5-side heating
- ☼ Heating elements on support rods
- ☼ 3-layer insulation structure
- ☼ Ideally suited for combined debinding-sintering processes



KE 100/13 DB



KE 200/13 DB



Ceramic tubes for consistent supply of flushing air

“System ROHDE” R-SiC ceiling supports prevent cracks and particles falling onto the products

Debinding Chamber Furnaces **KE-DB** series to 1400°C

Model	Volume	T <sub>max</sub> °C	Internal dimensions mm			External dimensions mm			Output kW	Supply A	Connector Plug	Voltage V	Weight kg
			b	t	h	B	T	H					
KE 200/13 DB	200	1300	460	630	680	800	1210	1770	29	42	CEE 63 A	400 V/50 Hz	416
KE 480/13 DB	480	1300	640	770	1020	980	1340	1830	56	81	-	400 V/50 Hz	630
KE 750/13 DB	750	1300	720	1100	1030	1570	1690	2010	80	116	-	400 V/50 Hz	1122
KE 1000/13 DB	1000	1300	920	1070	1140	1660	1610	2040	110	160	-	400 V/50 Hz	1250
KE 200/14 DB	200	1400	460	640	680	860	1280	1790	29	42	CEE 63 A	400 V/50 Hz	558
KE 480/14 DB	480	1400	630	770	995	1130	1410	1860	56	82	-	400 V/50 Hz	800
KE 750/14 DB	750	1400	720	1100	1030	1220	1750	1920	80	116	-	400 V/50 Hz	1250
KE 1000/14 DB	1000	1400	910	1005	1145	1400	1650	2150	110	160	-	400 V/50 Hz	1400

**Features** of the Debinding Chamber Furnaces KE-DB series



Combined debinding-sintering process



Ceramic flushing air tubes allow for even heat distribution



Removal of noxious gases through a separate flue system

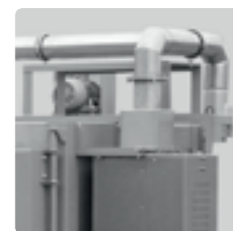

Subsequent treatment of exhaust gases optional

# ROHDE **TRUCK FURNACES**

**MEETS** YOUR REQUIREMENTS.



**Truck Furnaces HWE series**

ROHDE Truck Furnaces from the HWE series comprise models with furnace volumes between 1000 and 7000 litres and are suitable for temperature ranges up to 1000°C or 1300°C.

A truck furnace system is particularly suited to the heat treatment of large components that can be easily loaded outside the furnace. KANTHAL-A1 heating elements provide 5-side heating that ensures even heat distribution throughout the firing chamber and combined with a 3-layer insulation structure achieve a high energy efficiency.

Extensive optional accessories such as an automatic lifting door or additional trucks allow the furnace system to be adapted to any individual process flow.

In addition, ROHDE implements special solutions in accordance with individual internal dimensions and temperatures up to 1400°C.

- ☉ 5-side heating
- ☼ Heating elements recessed into bricks (HWE/10)  
Heating elements on support rods (HWE/13)
- ☽ 3-layer insulation structure
- ☾ Stable R-SiC ceiling support



HWE 1000/13



HWE 1500/13



Rail-mounted truck allows easy moving even for heavy charges

Corrosion protection and low external temperature due to in-frame ventilation

Truck Furnaces **HWE** series to 1300°C

Model Volume	T <sub>max</sub> °C	Internal dimensions mm			External dimensions mm			Output kW	Supply A	Connector Plug	Voltage V	Weight kg
		b	t	h	B	T	H					
HWE 1000/10	1000	850	1200	1000	1450	1800	2000	50	75	–	400 V/50 Hz	1200
HWE 1500/10	1000	1000	1500	1000	1600	2100	2000	70	105	–	400 V/50 Hz	1800
HWE 2000/10	1000	1000	2000	1000	1600	2600	2000	95	140	–	400 V/50 Hz	2300
HWE 3000/10	1000	1250	2400	1000	1850	3000	2000	125	185	–	400 V/50 Hz	3500
HWE 4000/10	1000	1250	3200	1000	1850	3800	2000	140	205	–	400 V/50 Hz	4500
HWE 6000/10	1000	1250	4000	1200	1850	4600	2000	160	235	–	400 V/50 Hz	6600
HWE 7000/10	1000	1250	4000	1400	1850	4600	2000	200	290	–	400 V/50 Hz	8000
HWE 1000/13	1300	850	1200	1000	1450	1800	2000	70	105	–	400 V/50 Hz	1200
HWE 1500/13	1300	1000	1500	1000	1600	2100	2000	95	140	–	400 V/50 Hz	1800
HWE 2000/13	1300	1000	2000	1000	1600	2600	2000	125	185	–	400 V/50 Hz	2300
HWE 3000/13	1300	1250	2400	1000	1850	3000	2000	140	205	–	400 V/50 Hz	3500
HWE 4000/13	1300	1250	3200	1000	1850	3800	2000	160	235	–	400 V/50 Hz	4500
HWE 6000/13	1300	1250	4000	1200	1850	4600	2200	200	290	–	400 V/50 Hz	6600
HWE 7000/13	1300	1250	4000	1400	1850	4600	2400	240	350	–	400 V/50 Hz	8000

**Optional accessories** for Truck Furnaces HWE series



Electrically operated truck



Hydraulic lifting door



Automatic exhaust air flaps

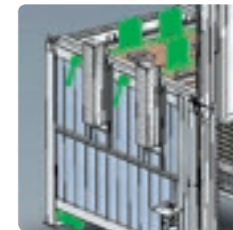

Automatic air supply and exhaust air flaps



Active cooling system



Second door for alternate operation



Loading station

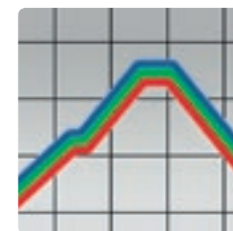

Multi-zone control

**Air Circulating Truck Furnaces HWU series**

ROHDE Air Circulating Truck Furnaces from the HWU series comprise models with furnace volumes between 1000 and 7000 litres and are suitable for temperature ranges up to 650°C or 850°C.

3-side heating provides the best possible transfer of energy to the firing chamber. ROHDE-designed air circulating fans are decoupled from the drive motor and are quiet, durable and easy to service.

KANTHAL-A1 heating elements and a 2-layer insulation structure ensure an ideal temperature rise even in the upper temperature range resulting in very low energy consumption. Other product characteristics are corrosion protection due to the fully in-frame ventilated steel construction and the mortar-free ceiling of lightweight firebricks with R-SiC ceiling supports.

- ☉ 3-side heating
- ☼ Heating elements recessed into bricks
- ☼ 2-layer insulation structure
- ☼ Powerful air circulating fan



HWU 1000/65



HWU 1000/65



2-layer wall structure, heating elements mounted in protected position recessed into bricks

Powerful air circulation allows for high temperature accuracy

**Air Circulating Truck Furnaces HWU series to 850°C**

Model Volume	T <sub>max</sub> °C	Internal dimensions mm			External dimensions mm			Output kW	Supply A	Connector Plug	Voltage V	Weight kg
		b	t	h	B	T	H					
HWU 1000/65	650	850	1200	1000	1450	1800	2000	45	65	–	400 V/50 Hz	1200
HWU 1500/65	650	1000	1500	1000	1600	2100	2000	60	90	–	400 V/50 Hz	1800
HWU 2000/65	650	1000	2000	1000	1600	2600	2000	80	116	–	400 V/50 Hz	2300
HWU 3000/65	650	1250	2400	1000	1850	3000	2000	100	145	–	400 V/50 Hz	3500
HWU 4000/65	650	1250	3200	1000	1850	3800	2000	120	175	–	400 V/50 Hz	4500
HWU 6000/65	650	1250	4000	1200	1850	4600	2200	140	205	–	400 V/50 Hz	6600
HWU 7000/65	650	1250	4000	1400	1850	4600	2400	160	235	–	400 V/50 Hz	8000
HWU 1000/85	850	850	1200	1000	1450	1800	2000	45	65	–	400 V/50 Hz	1200
HWU 1500/85	850	1000	1500	1000	1600	2100	2000	60	90	–	400 V/50 Hz	1800
HWU 2000/85	850	1000	2000	1000	1600	2600	2000	80	116	–	400 V/50 Hz	2300
HWU 3000/85	850	1250	2400	1000	1850	3000	2000	100	145	–	400 V/50 Hz	3500
HWU 4000/85	850	1250	3200	1000	1850	3800	2000	120	175	–	400 V/50 Hz	4500
HWU 6000/85	850	1250	4000	1200	1850	4600	2200	140	205	–	400 V/50 Hz	6600
HWU 7000/85	850	1250	4000	1400	1850	4600	2400	160	235	–	400 V/50 Hz	8000

**Optional accessories for Air Circulating Truck Furnaces HWU series**



Electrically operated truck



Hydraulic lifting door



Automatic exhaust air flaps

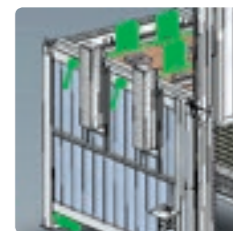

Automatic air supply and exhaust air flaps



Active cooling system



Second door for alternate operation



Loading station



Individual measuring and control technology



**Gas-fired Truck Furnaces HWG series**

ROHDE Gas-fired Truck Furnaces from the HWG series comprise models with furnace volumes between 1000 and 10000 litres and are suitable for temperature ranges up to 1000°C and 1300°C.

ROHDE uses the HWG series to combine the versatility of truck furnaces with the performance of modern forced draught burners. The burner system is very efficient and its high power density allows connected loads that if performed electrically, required much more expense.

Gas-fired truck furnaces can be used for annealing of heavy castings or firing of ceramics and meet the highest requirements imposed on the atmosphere. Depending on the required application, the burner position can be adapted to individual processes.

Combined with a wide range of optional equipment, ROHDE develops customised solutions to meet different requirements.

- ☉ Heating using powerful forced draught burners
- ☼ Elster-Kromschröder Low NOx Burners
- ☐ 3-layer insulation structure
- ☼ All relevant functions combined in one system

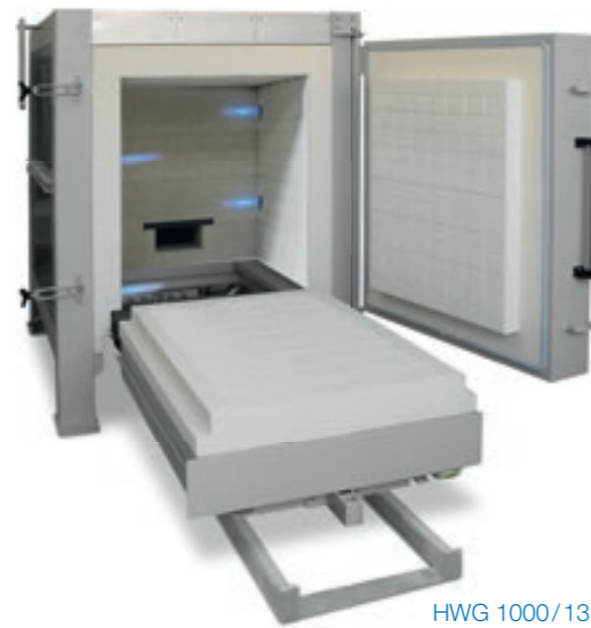

HWG 1000/13



HWG 2000/10

Safe and clear valve section, easy-to-read instruments

Effective labyrinth seal, easy to re-adjust



**Gas-fired Truck Furnaces HWG series to 1300°C**

Model Volume	T <sub>max</sub> °C	Internal dimensions mm			External dimensions mm			Output kW	Supply A	Connector Plug	Voltage V	Weight kg
		b	t	h	B	T	H					
HWG 1000/10	1000	850	1000	1200	1300	1800	2200	110	-	-	400 V/50 Hz	1600
HWG 2000/10	1000	1000	2100	1200	1450	2900	2200	160	-	-	400 V/50 Hz	2400
HWG 5000/10	1000	1500	2500	1350	1950	3300	2350	200	-	-	400 V/50 Hz	4500
HWG 10000/10	1000	1600	4500	1400	2050	5300	2400	240	-	-	400 V/50 Hz	9600
HWG 1000/13	1300	850	1000	1200	1300	1800	2200	130	-	-	400 V/50 Hz	1600
HWG 2000/13	1300	1000	2100	1200	1450	2900	2200	200	-	-	400 V/50 Hz	2400
HWG 5000/13	1300	1500	2500	1350	1950	3300	2350	300	-	-	400 V/50 Hz	4500
HWG 10000/13	1300	1600	4500	1400	2050	5300	2400	360	-	-	400 V/50 Hz	9600

**Optional accessories for Gas-fired Truck Furnaces HWG series**

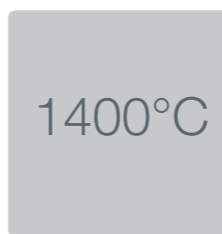

1400°C

Designed for use at 1400°C Tmax



Atmosphere control

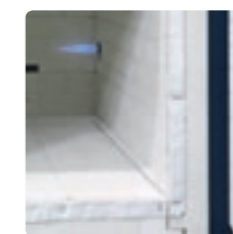

Reduction-resistant insulation structure

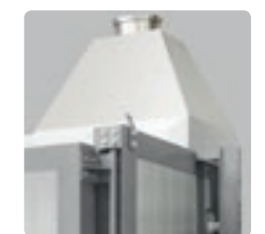

Subsequent treatment of exhaust gases



Electrically operated truck



Hydraulic lifting door



Loading station



Individual measuring and control technology

**HIDDEN** POWER.

# ROHDE **HOOD FURNACES**



**Hood Furnaces HE series**

ROHDE Hood Furnaces from the HE series comprise models with furnace volumes between 60 and 630 litres and are suitable for temperature ranges up to 1000°C and 1300°C.

This type of construction is characterised by a hood with linear movement allowing safe and easy loading on several sides even for heavy charges. The high-quality insulation structure combined with 5-side heating make ROHDE Hood Furnaces ideally suitable for applications imposing high requirements on loading.

A linear guide rail allows precise hydraulic lifting and lowering of the robust hood. The in-frame ventilated furnace housing provides effective protection against corrosion. Like all ROHDE industrial furnaces, KANTHAL heating elements have been calculated with a minimal surface load minimising wear and ensuring a long service life.

On request, ROHDE develops customised solutions to meet your production requirements, such as the addition of an extendable floor (ELS Ergo Load System) to the hood construction.

- ☉ 5-side heating
- ☼ Heating elements on support rods
- ☼ 3-layer insulation structure
- ☼ Easy loading on three sides



HE 120/10



HE 210/13

Robust linear guide for continuous hood lifting

Easy-to-maintain switchgear at the back of furnace, easily accessible



**Optional accessories** for Electric Hood Furnaces HE series



Automatic exhaust air flaps



Automatic air supply and exhaust air flaps



Active cooling system



Semi gas-tight construction with protective gas connection



Electrically extendable furnace floor (ELS)



Replacement floor, adjustable in height

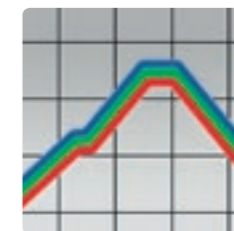

Multi-zone control



Individual measuring and control technology

**Electric Hood Furnaces HE series to 1300°C**

Model	Volume	T <sub>max</sub> °C	Internal dimensions mm			External dimensions mm			Output kW	Supply A	Connector Plug	Voltage V	Weight kg
			b	t	h	B	T	H					
HE 60/10	60/10	1000	400	400	400	800	1500	2150	7	16	CEE 16 A	400 V/50 Hz	360
HE 120/10	120/10	1000	500	500	500	900	1600	2250	11	16	CEE 16 A	400 V/50 Hz	650
HE 200/10	200/10	1000	600	600	600	1000	1700	2350	15	22	CEE 32 A	400 V/50 Hz	1000
HE 360/10	360/10	1000	1000	600	600	1400	1700	2350	22	32	CEE 32 A	400 V/50 Hz	1400
HE 630/10	630/10	1000	1300	700	700	1750	1850	2450	32	47	CEE 63 A	400 V/50 Hz	1800
HE 60/13	60/13	1300	400	400	400	800	1500	2125	11	16	CEE 16 A	400 V/50 Hz	360
HE 120/13	120/13	1300	500	500	500	900	1600	2250	15	22	CEE 32 A	400 V/50 Hz	650
HE 200/13	200/13	1300	600	600	600	1000	1700	2350	22	32	CEE 32 A	400 V/50 Hz	1000
HE 360/13	360/13	1300	1000	600	600	1400	1700	2350	40	58	CEE 63 A	400 V/50 Hz	1400
HE 630/13	630/13	1300	1300	700	700	1750	1850	2450	60	86	-	400 V/50 Hz	1800

ALL GOOD THINGS COME **FROM ABOVE.**

# ROHDE **TOPLOADERS**



**Regeneration Furnaces TE-DPF series**

ROHDE Regeneration Furnaces from the TE-DPF series comprise models with furnace volumes between 100 and 220 litres and are suitable for temperature ranges up to 800°C.

This series has been designed for controlled and reliable burning-off of Diesel Particulate Filters (DPF) from exhaust systems in buses, construction machines, trucks, cars or generators.

The robust furnaces are ideally suited for heavy use in vehicle depots, on construction sites and in workshops. The TE-DPF series is characterised by a stable base frame with large, easy-to-move transport castors and a high-quality and energy-efficient lightweight firebrick lining.

Particular importance was attached to the safe and especially intuitive control of thermal cleaning processes. The easy-to-operate process controller is pre-programmed but can be adjusted manually to suit different particulate filter sizes with just a few steps. This ensures a very quick and closed cleaning process.

- ☉ All-around heating with floor heating
- ☼ Heating elements recessed into bricks
- ☼ 2-layer insulation structure
- ☼ Easy burning-off of particulate filters



TE 200/80 DPF



Easy-to-operate using preset programs  
Stable and robust transport castors

**Shaft Furnace BT series**

ROHDE Shaft Furnaces from the BT series comprise two models with furnace volumes between 300 and 500 litres and are suitable for the temperature range up to 1300°C.

This series combines 5-side heating in a robust chamber furnace construction with all the advantages of a toploader. The high-quality insulation structure and the even temperature distribution make the shaft furnace suitable for applications where as many goods as possible must be placed and processed in one firing process. The shaft furnace offers an excellent overview during charging.

The in-frame ventilated lid and the use of galvanized steel sheet in the furnace casing provide effective protection against corrosion. Another feature of this design is the carefully manufactured furnace lid. It is provided with a gas pressure spring that allows easy opening of the lid. KANTHAL heating elements have been calculated with minimal surface load to minimise wear and to ensure a long service life.

- ☉ 5-side heating
- ☼ Heating elements recessed into bricks
- ☼ 2-layer insulation structure
- ☼ Easy top loading



BT 300/13



2-layer wall structure, heating elements mounted in protected position recessed into bricks

Easy lid opening and closing using gas pressure springs

Electric Toploaders **TE-DPF** series to 800°C

Model Volume	T <sub>max</sub> °C	Internal dimensions mm			External dimensions mm			Output kW	Supply A	Connector Plug	Voltage V	Weight kg
		b	t	h	B	T	H					
TE 100/80 DPF	800	∅ 470	570	750	750	900	5,0	8	CEE 16 A	400 V/50 Hz	95	
TE 200/80 DPF	800	∅ 590	800	830	880	1140	9,0	13	CEE 16 A	400 V/50 Hz	150	

Electric Toploaders **BT** series to 1300°C

Model Volume	T <sub>max</sub> °C	Internal dimensions mm			External dimensions mm			Output kW	Supply A	Connector Plug	Voltage V	Weight kg
		b	t	h	B	T	H					
BT 300/13	1300	920	570	610	1360	970	1070	15,0	25	CEE 32 A	400 V/50 Hz	400
BT 500/13	1300	1150	650	690	1620	1050	1150	24,0	34	CEE 63 A	400 V/50 Hz	535

A REALLY  
CLEAN JOB.



# ROHDE EXHAUST AIR CLEANING



**Catalytic Post-Combustion CPC**

Many thermal processes generate exhaust air components that cannot be directed into the environment without treatment thus requiring suitable exhaust air cleaning. ROHDE cooperates with well-known experts for catalytic post-combustion to meet these requirements.

Catalytic treatment of exhaust air is mainly used in small to medium exhaust gas flow rates and its energy is ideally suited to meet requirements imposed exclusively from cleaning of hydrocarbon compounds. When using catalytic post-combustion, exhaust air treatment can be effected at low temperatures – depending on the composition of the noxious gases, oxidation occurs between 250°C and 400°C in the catalyser. In many cases, the low reaction temperature allows cleaning without performing an additional heating of the noxious gas and thus a very efficient operation.

We are able to offer exhaust air treatment in one compact system comprising a furnace and CPC or in a stand-alone variant that can be installed in existing furnace concepts later.

The advantage of a solution from a single source: we customise the complete system comprising furnace, catalyst and shared process controller if needed to suit your required process thus allowing the best possible synergies.

The entire system i.e. furnace and catalytic exhaust air treatment is controlled along with the firing process inside the chamber taking into account a safe and energy-efficient manufacturing process.



Catalytic post-combustion, Allok 320 (Allog Engineering)



KEU 600/75 with integrated catalytic exhaust air cleaning

**Thermal Post-Combustion TPC**

We are also able to offer solutions for processes that generate noxious gases and require thermal post-combustion (TPC).

Thermal post-combustion is especially used for higher exhaust gas flow rates generated during cleaning or burning-out of plastics from moulds used for Rapid Prototyping.

The functional principle of thermal post-combustion is based on oxidation. With the exception of some substances such as halogens or sulphur that do not undergo thermal decomposition, all substances in the exhaust gas volume are converted to H<sub>2</sub>O (water) and CO<sub>2</sub> (carbon dioxide). The system is therefore ideally suited for debinding processes generating high volumes of exhaust gases or damaging the catalyser with noxious gas components.

We are able to offer complete solutions that meet your requirements and integrate thermal post-combustion from well-known manufacturers in our furnace concepts to avoid unnecessary interfaces. You receive a complete system with a compact control unit for measuring and monitoring.



Thermal post-combustion TPC, vertical (Birk Wärmetechnische Anlagen)



Thermal post-combustion TPC, horizontal (Birk Wärmetechnische Anlagen)

# ROHDE MEASURING AND CONTROL TECHNOLOGY

CONTROLLERS TO SUIT **YOUR REQUIREMENTS.**





**Manual Controller  
Bentrup TC 504**

High-performance control unit with the highest security standard and high operating comfort. Clear presentation of actual and setpoint values in demanding workshop and laboratory applications.

- Units displayed on easy-to-read LED display (actual and setpoint values)
- Clear and easy-to-read display, intuitive operating layout
- 10 freely programmable firing programs, 2 segments each
- Available with zone control



**Manual Controller  
Bentrup TC 88e**

High-performance control unit with the highest security standard and high operating comfort. Clear presentation of actual and setpoint values in demanding workshop and laboratory applications.

- Units displayed on easy-to-read LED display (actual and setpoint values)
- Clear and easy-to-read display, intuitive operating layout
- 3 freely programmable firing programs, 9 segments each
- Program time delay or program start delay can be adjusted
- Optional version with 20 programs and up to 15 segments available



**Manual Controller  
Bentrup TC 507**

High-performance control unit with the highest security standard and high operating comfort. Clear presentation of actual and setpoint values in demanding workshop and laboratory applications.

- Units displayed on easy-to-read LED display (actual and setpoint values)
- Clear and easy-to-read display, intuitive operating layout
- 50 freely programmable firing programs, 2 segments each
- Available with zone control
- Program time delay or program start delay can be adjusted
- Additional switch outputs (optional)



**Compact Controller  
JUMO dTRON**

High-performance panel-mounted control unit with the highest security standard and high operating comfort. Clear presentation of actual and setpoint values in demanding workshop and laboratory applications.

- Compact controller can be integrated into the kiln casing, saving space
- Including ramp function, timer start, manual mode
- Configurable user level enables setting of the most important parameters
- Individual controller optimisation to adjust to furnace requirements
- Clear presentation of actual and setpoint values



**Compact Controller  
Bentrup TC 2088**

High-performance panel-mounted control unit with the highest security standard and high operating comfort. Clear presentation of actual and setpoint values in demanding workshop and laboratory applications.

- Units displayed on easy-to-read LED display (actual and setpoint values)
- Clear and easy-to-read display, intuitive operating layout
- 3 freely programmable firing programs, 9 segments each
- Program time delay or program start delay can be adjusted
- Optional version with 20 programs and up to 15 segments available



**Comfort Controller  
JUMO Dicon Touch**

Universal process and program controller using brilliant TFT colour graphic screen visualisation, intuitive to operate with touch screen.

- Alphanumeric display saves 10 programs with up to 50 program segments, 2 events (e.g. air supply and exhaust air flap) individually programmable
- Clear presentation of relevant process values
- Integrated paperless recorder, tamper-resistant data storage
- Process data can be collected using USB stick or Ethernet connection and exported to the PC using software
- Integrated timer and time switch for program start
- Available as completely attachable controller



**Comfort Controller  
JUMO IMAGO 500**

Comfortable program controller, clear program input and individual editing of program names.

- Multi-channel process and program controller
- 5" colour graphic display (27 colours)
- 144 x 130 mm format (92 x 92 mm installation dimensions)
- 50 programs with up to 100 program steps (segments)
- Freely configurable screen masks allow intuitive operation
- Clear presentation of relevant process values
- Program start programmable using real time clock
- Configuration using software or display



**Paperless Recorder  
JUMO Logoscreen nt**

Records and files up to 18 process values using different media with batch reporting via barcode scanner. A colour display ensures clear presentation of process values.

- To be operated using one operating element (push and turn)
- Presentation of measured values in different diagrams
- Batch reporting on 5.5" TFT colour graphics screen
- Ethernet, integrated web server
- Evaluation of firing curves using PC



**Paperless Recorder  
JUMO LOGOSCREEN 600**

Records and stores different process values using different media with batch reporting.

- Paperless screen recorder with 5.7" TFT colour display
- Intuitive touch operation
- Up to 6 universal measurement inputs, up to 2 analogue outputs
- Up to 24 external analogue or digital measurement channels
- Up to 6 customer-specific process screens
- Horizontal or vertical line diagram
- Batch report recording
- Efficient evaluation and setup software as accessory
- IP 65 protection



**Comfort Controller  
Siemens S7-1200 with Panel TP 700**

Freely programmable control system to meet individual customer requirements. Controller is operated using Siemens Comfort Touchpanel with customised layout.

- Siemens programmable logic controller to meet individual requirements
- ROHDE user interface, individually programmable to suit your requirements
- Controller operated using TP 700 Comfort Panel with 7" Touch TFT widescreen display
- Switch outputs can be set separately at every program segment
- Control zone offset can be set at every program segment
- Presentation of firing curves and message archive for plant status reports
- Clear presentation of processes and process information on display
- User administration and process storage using USB port
- Data recording and storing using different media
- Remote maintenance optional



**Comfort Controller  
Siemens S7-1500 with Panel TP 900**

Freely programmable control system to meet individual customer requirements. Controller is operated using Siemens Comfort Touchpanel with customised layout.

- Siemens programmable logic controller to meet individual requirements
- ROHDE user interface, individually programmable to suit your requirements
- Controller operated using TP 900 Comfort Panel 9" with Touch TFT widescreen display
- Switch outputs can be set separately at every program segment
- Control zone offset can be set at every program segment
- Presentation of firing curves and message archive for plant status reports
- Clear presentation of processes and process information on display
- Data recording and storing using different media
- User administration
- Remote maintenance optional



alu druckguss lübeck GmbH  
 Black & Decker Deutschland GmbH  
 Baker Hughes INTEQ GmbH  
 CADdent GmbH  
 Constellium Singen GmbH  
 Continental Mechanical Components Germany GmbH  
 Daimler AG  
 Deutsche Solar GmbH  
 Deutsches Zentrum für Luft und Raumfahrt e. V.  
 Eberspächer Exhaust Technology GmbH & Co. KG  
 ElringKlinger AG  
 Federal-Mogul Nürnberg GmbH

OUR **BEST REFERENCE:**  
 CUSTOMER SATISFACTION

Germanischer Lloyd Prüflabor GmbH  
 Heraeus Quarzglas GmbH & Co. KG  
 Hase Kaminofenbau GmbH  
 IMBA Institut für Molekulare Biotechnologie GmbH  
 Jenoptik Katarorb GmbH  
 KPM Königliche Porzellan-Manufaktur Berlin GmbH  
 Lufthansa Technik AG  
 Merck KGaA  
 NighTec Industries GmbH  
 OCULUS Optikgeräte GmbH  
 PolyOne Th. Bergmann GmbH  
 Quality Analysis GmbH  
 Sensata Technologies Bulgaria EOOD  
 Salzgitter Bauelemente GmbH  
 Schott Glas AG  
 Treibacher Industrie AG  
 Tyrolit Schleifmittelwerke Swarovski K.G.  
 Universität Bayreuth, Lehrstuhl Metallische Werkstoffe  
 Voith Turbo BHS Getriebe GmbH  
 voestalpine Stahl GmbH  
 Whitepeaks Dental Solutions GmbH & Co. KG

MISSION **POSSIBLE.**



Anything is possible. ROHDE provides the best solution for you either from its wide basic range of products or with a special customised construction. Contact ROHDE and see for yourself.

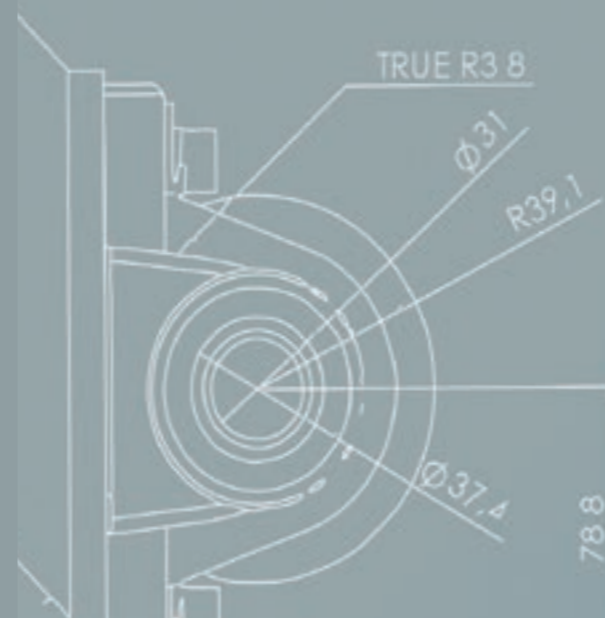

CHAIN LINKS  
**ANNEALING AND HARDENING.**



# CUSTOM-DESIGNED **CHAMBER FURNACES**



**Gradient Furnace ME 65/10**

- ⊕ 350 x 650 x 250 mm (wxdxh)
- ⊙ 20 kW
- Ⓢ 1000°C
- ☆ 3 different temperature zones, customised feeder unit and charging tray



**Burn-out Furnace KE 1000/11**

- ⊕ 1300 x 700 x 1130 mm (wxdxh)
- ⊙ 70 kW
- Ⓢ 1100°C
- ☆ Controlled exchange of air to 300 m³/h, hot gas valve, automatic exhaust air flaps and cooling system



**Preheating Furnace ELS 200/85 U**

- ⊕ 460 x 640 x 1145 mm (wxdxh)
- ⊙ 13,2 kW
- Ⓢ 800°C
- ☆ Extendable furnace floor (ELS), hydraulic lifting door



**Sintering Furnace ELS 1000/13**

- ⊕ 910 x 1005 x 1145 mm (wxdxh)
- ⊙ 70 kW
- Ⓢ 1350°C
- ☆ Electrically extendable floor (ELS), separate data recording, automatic exhaust air flaps and cooling system



# CUSTOM-DESIGNED **TRUCK FURNACES**

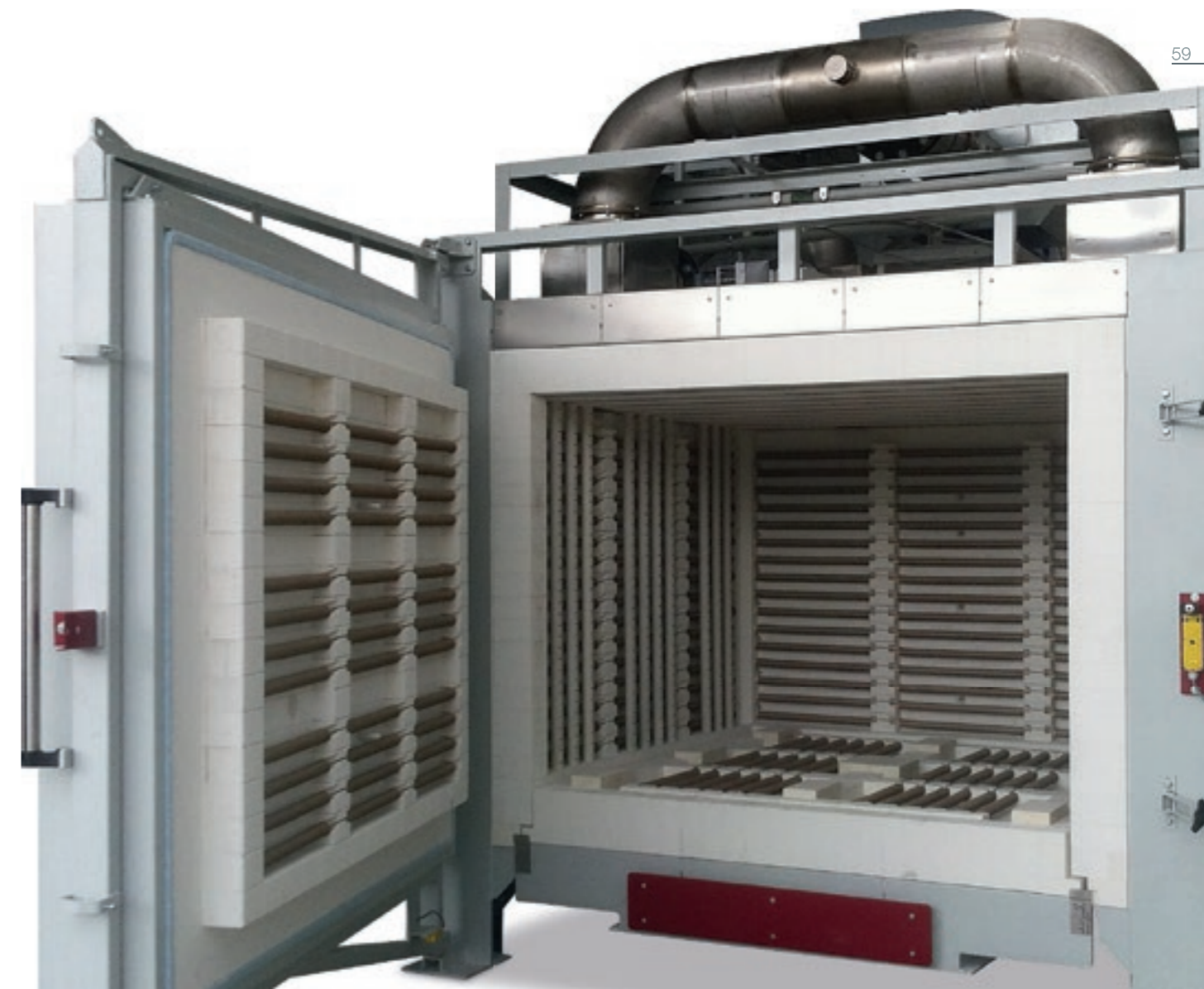

ABRASIVES  
**DEBINDING.**

**Debinding-Sintering Furnace  
HWE 4700/14 DB**

- ⊕ 1900 x 1900 x 1300 mm (wxdxh)
- ⊙ 300 kW
- Ⓢ 1400°C
- ☆ Debinding package including air preheating, negative pressure control, second truck, process documentation

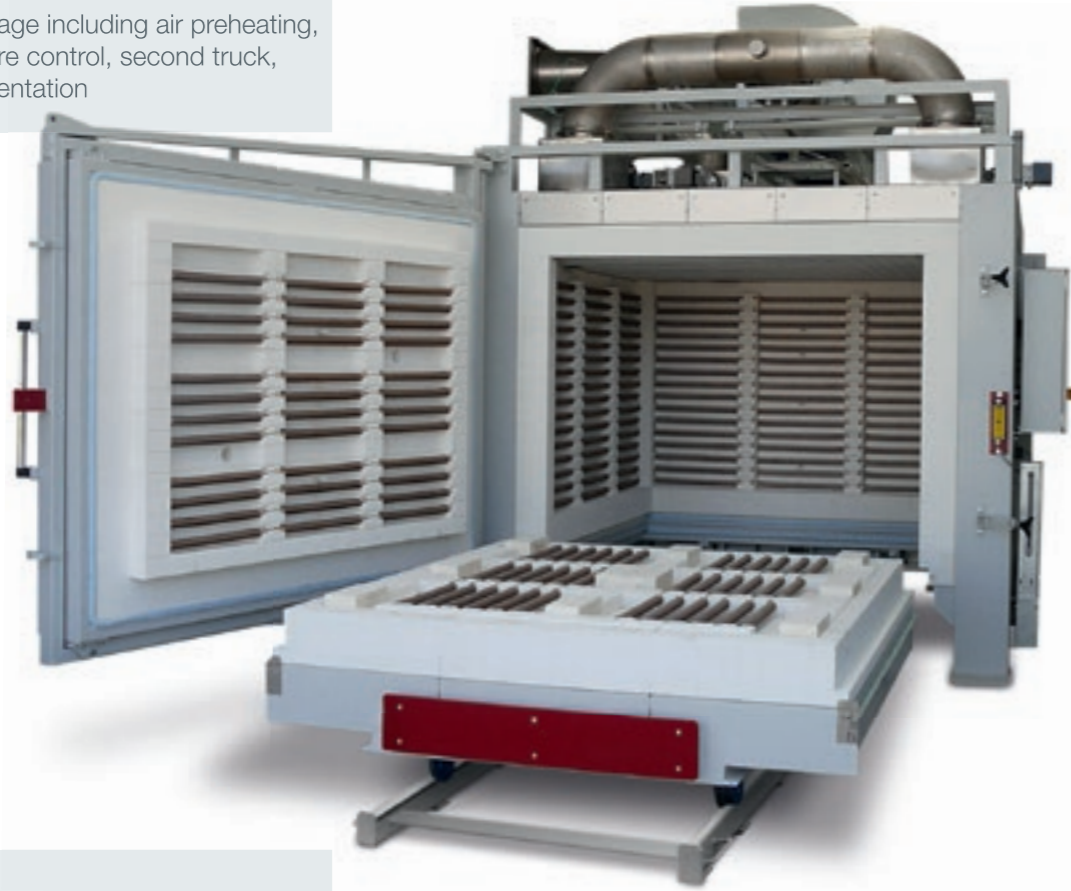

**Annealing Furnace HWU 3300/75**

- ⊕ 1450 x 2100 x 1100 mm (wxdxh)
- ⊙ 100 kW
- Ⓢ 750°C
- ☆ Automatic exhaust air flaps, two hydraulic lifting doors, second truck, fully-automated process



**Preheating Furnace HWU 12500/65**

- ⊕ 2500 x 2500 x 2000 mm (wxdxh)
- ⊙ 350 kW
- Ⓢ 560°C
- ☆ Automatic air supply and exhaust air flaps, controlled cooling system, electrically operated truck, air-conditioned switch cabinet



**Sintering Furnace HWE 2400/14 SG**

- ⊕ 1550 x 1500 x 980 mm (wxdxh)
- ⊙ 190 kW
- Ⓢ 1400°C
- ☆ Semi-gas tight construction, hydraulic lifting door, automatic air supply and exhaust air flaps, controlled cooling system



# CUSTOM-DESIGNED **HOOD FURNACES**



GLASS CERAMICS  
**TEMPERING.**



**Preheating Furnace HE 335/80**

- ⊕ ∅ 610 x 1100 mm (∅xh)
- ⊕ 25 kW
- ⊕ 800°C
- ☆ Hydraulic lifting table, separate storage area, automated movement, special voltage (480 V)



**Hood Furnace FE 1200/10**

- ⊕ 2410 x 1410 x 360 mm (wx dxh)
- ⊕ 80 kW
- ⊕ 1000°C
- ☆ Pneumatic hood lifting, integration into robot cell, comprising transport castors



**Fusing Furnace FE 5200/10**

- ⊕ 6000 x 2650 x 330 mm (wx dxh)
- ⊕ 110 kW
- ⊕ 1000°C
- ☆ Hydraulic hood movement, furnace floor can be moved, automatic exhaust air flaps



**Annealing Furnace HE 210/80**

- ⊕ 600 x 600 x 600 mm (wx dxh)
- ⊕ 22 kW
- ⊕ 800°C
- ☆ Extendable furnace floor (ELS), hydraulic hood lifting



# CUSTOM-DESIGNED **TOPLOADERS**

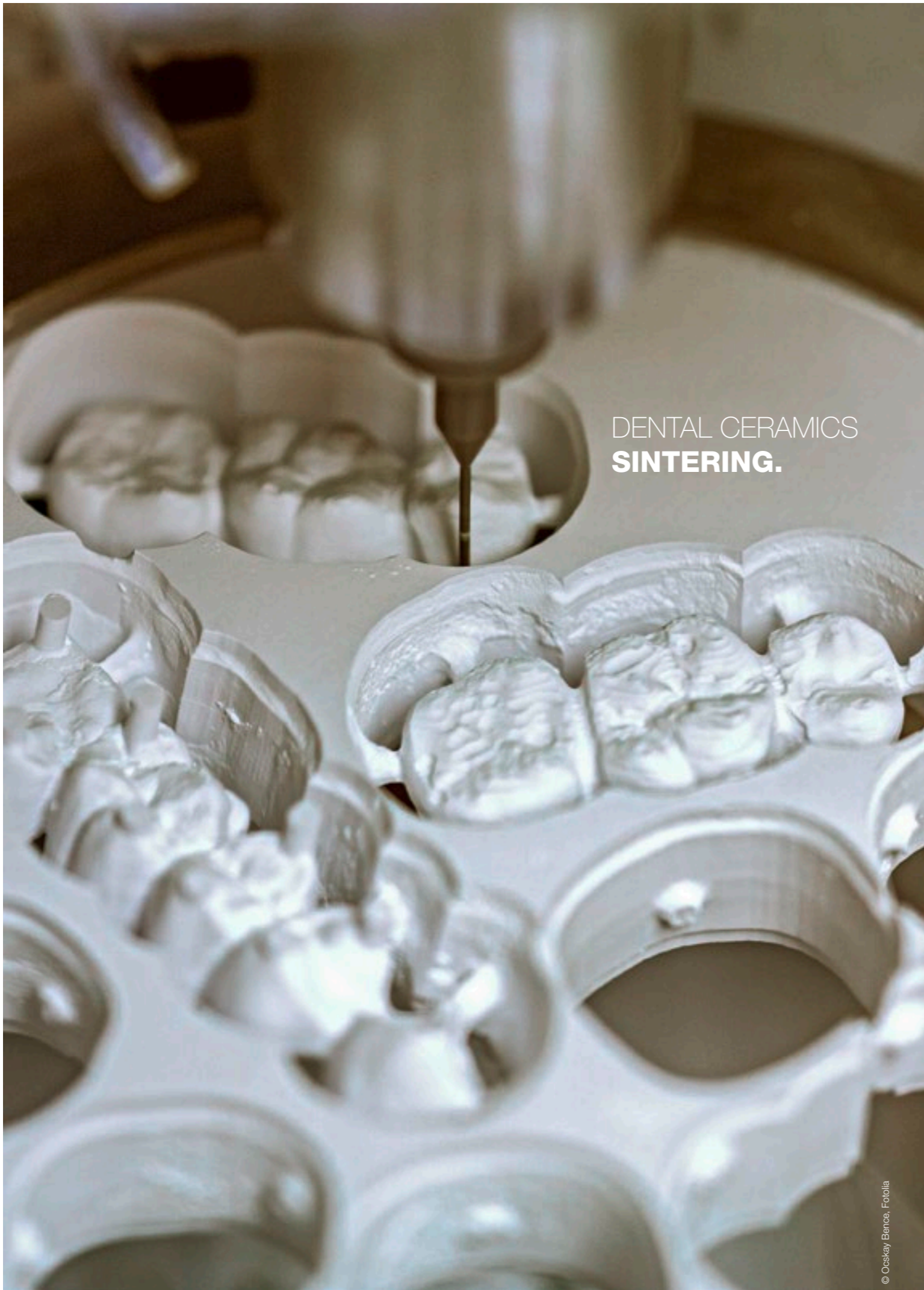

DENTAL CERAMICS  
**SINTERING.**

© Oeskey Benes, Fotolia



**Curing Furnace TE 585/12**

- ⊕ ∅ 990 x 760 mm (∅xh)
- ⊙ 33 kW
- Ⓢ 1250°C
- ☆ Pneumatic lid opening



**Vertical Furnace S 40/10**

- ⊕ 500 x 500 x 630 mm (wxdxh)
- ⊙ 24 kW
- Ⓢ 1050°C
- ☆ Pneumatic lifting gear



**Preheating Furnace BT 290/10**

- ⊕ 1400 x 600 x 600 mm (wxdxh)
- ⊙ 22 kW
- Ⓢ 1000°C
- ☆ 2 heating zones, customised device to collect components



**Tin Bath Furnace ZT 250/50**

- ⊕ 770 x 580 x 730 mm (wxdxh)
- ⊙ 30 kW
- Ⓢ 550°C
- ☆ Melting tank, cascade control



### On-site instruction and initial operation

ROHDE provides project planning and is able to arrange for proper transportation, on-site instruction and initial operation of your furnace system if required.

This guarantees safe, fast and successful commencement of production from the start. Of course, ROHDE is your partner when it comes to service and on-site maintenance work.

### Warranty and spare part service

ROHDE deliberately refuses to reduce the warranty period. Despite commercial furnaces being used intensely, ROHDE guarantees a 2-year warranty on all standard products excluding parts that are subject to wear.

ROHDE assures reliable and quick supply of spare parts when service is required. Spare parts are usually ready for dispatch 24 hours after receipt of order.

ROHDE always uses environmentally friendly materials and guarantees acceptance of each ROHDE product for the recycling of reusable parts or environmentally sound disposal.



Delivery and set-up service



On-site instruction and initial operation



2-year warranty



Spare parts and service



Environmentally sound materials and recycling

**COMMITTED TO SERVICE.**

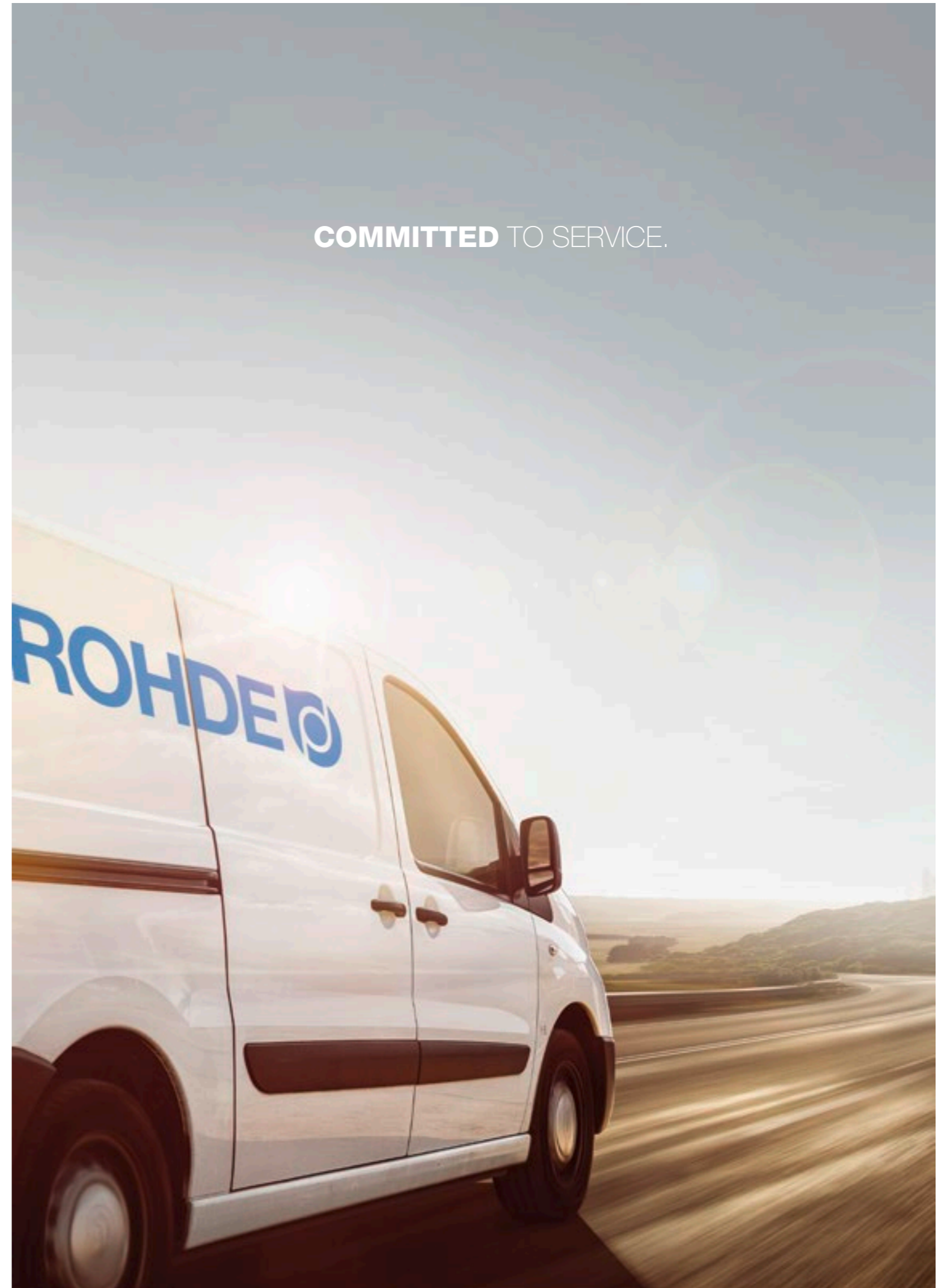

Please visit [www.rohde-online.net/industry](http://www.rohde-online.net/industry)  
for further information.



11/2017  
989321

**ROHDE** 

Helmut ROHDE GmbH  
Ried 9  
83134 Prutting, Germany  
Phone +49 8036 674976-10  
Fax +49 8036 674976-19  
[info@rohde-online.net](mailto:info@rohde-online.net)  
[www.rohde-online.net](http://www.rohde-online.net)